

Final Public Synthesis Report

Organic and Fair Palm Oil Production – Assessment Project

Project Duration: 01.10.2018 – 31.03.2019



Thomas Bernet & Paul van den Berge

Frick, June 2019

This document summarizes activities and findings of the ‘Organic and Fair Palm Oil Production Assessment Project’ jointly funded by the Coop Fund for Sustainability and the Swiss State Secretariat for Economic Affairs (SECO).

This project is supported by the
Coop Sustainability Fund.



Schweizerische Eidgenossenschaft
Confédération suisse
Confederazione Svizzera
Confederaziun svizra

Swiss Confederation

Federal Department of Economic Affairs,
Education and Research EAER
State Secretariat for Economic Affairs SECO

Executive summary

Background & project rationale

Over the last 15 years, global palm oil production has more than doubled. Indonesia and Malaysia alone produce more than 80 % of all palm oil today. Being the cheapest vegetable oil available on the world market—thanks to high hectare yields of oil palms—both demand and supply for palm oil continue to grow. Particularly, the further expansion of monocultures set in place by big companies is critical, as there is strong evidence that palm oil production goes hand in hand with deforestation, biodiversity losses, land tenure conflicts, and negative social impacts. In this regard, also the different palm oil specific certification schemes, including RSPO, have been criticized for not effectively encountering the (mentioned) negative environmental and social impacts.

In Switzerland, Coop assessed the situation of palm oil use in around 1300 own-brand products and developed its own palm oil vision during 2018, stimulated by the growing number of customers and NGOs questioning and disapproving the use of palm oil. According to this vision, all palm oil in own-brand food products must be replaced either by Bio Suisse certified palm oil or by other oils and fats—if feasible from a sensory and technical point of view. In regard to the former, two questions emerged: “*To what extent can Bio Suisse certified palm oil claim better ‘sustainability effects’ than non-organic palm oil?*”, and “*Will there be a sufficient supply base for Coop to source Bio Suisse certified palm oil in the near future?*”

In order to answer these two questions, FiBL was tasked to implement an ‘assessment project’. SECO agreed to co-fund the study for sharing the concern in finding ways to increase the ‘sustainability performance’ of palm oil production, in general. SECO increased the special interest to clarify, as part of the study, to what extent smallholders are and can be involved in ‘sustainable palm oil production’. For this reason, different production sites of the SECO-supported ‘Sustainable West Africa Palm Oil Programme’ in Ghana were included in the study. This ‘smallholder perspective’ was also of greatest relevance for Bio Suisse’s standard development work, aiming to strengthen the social impact with additional, smallholder-specific certification criteria.

Project methodology & company sample

As a means to explicitly assess the ‘sustainability performance’ of different palm oil production schemes—relating to conventional, RSPO, fair trade, and organic certification—FiBL developed the so-called ‘palm oil hotspot analysis’. This qualitative tool guided FiBL experts in their work to consciously reflect 22 explicit ‘sustainability hotspots’ when visiting different palm oil producing companies and interacting with their staff and supplying farmers.

This methodological tool was first applied and tested in 5 companies in Ghana: 3 did not have any certification (i.e. conventional), 1 had RSPO certification only, and 1 had both a fair trade (Fair for Life) and organic (EU Regulation) certification. Later, the 3 only companies that are Bio Suisse certified were visited and assessed as well, located in Brazil, Colombia, and Madagascar.

Main findings & conclusions

The assessment reveals important ‘sustainability performance’ differences among the visited companies. **Conventional farms have a much lower overall ‘sustainability scoring’ despite of playing a key role in creating essential income in rural areas**, owing to the fact that they have a high share of (smallholder) farmers supplying fresh fruit bunches (FFBs) to their mills. Compared to all other companies involved in the assessment, they face the strongest financial constraints. Often being of smaller size, conventional companies are mainly competing in the national market,

and their efforts go mainly into expanding both the FFB sourcing and the mill's capacity. With this priority and facing financial constraints, they are not doing the required investments to score high in different meaningful 'sustainability hotspots'. **While the 'RSPO only' company receives average scores—partly due to the common use of chemicals (i.e. mineral fertilizers and herbicides), which imply lower environment-related scores—all organically certified companies, being also either fair trade or RSPO-certified, receive 'good' and 'very good' scores.** They are in a position to claim higher prices in the international market for their quality oil. For paying higher FFB prices to their outgrower farmers, making considerable social investments, and relying on organic practices (i.e. no use of chemicals), they score high in all impact areas: 'land use', 'oil quality', 'environmental impact', and 'social impact'.

The findings also reveal that the involvement of **smallholder farmers is common and feasible in all palm oil business models—but it requires considerable investment in order to be ideal.** In fact, there are big differences in the quality of cooperations between palm oil companies and FFB supplying farmers. Certified companies (organic, fair, RSPO) have clearly better cooperation mechanisms with supplying farmers. Not only are prices paid for FFB higher, but the services provided to farmers are of better quality, i.e. improving access to loans, extension services, harvesting tools, production inputs, and FFB transportation.

Interestingly, **RSPO certification adds important value to organically certified companies:** while organic certifications boost environmental performance, the RSPO standard provides an interesting incentive to perform well in 'social accountability' and 'transparency'. Especially 'transparency' efforts lead to proactive and open communication, which ultimately enhances fruitful stakeholder interaction, functional learning, and the company's image—all contributing to further improve the company's performance.

Final reflection

These findings impel that the 'sustainability discussion' about palm oil must continue. The good 'sustainability scoring' of organic and fair trade companies leads to the premise that "yes, palm oil can be produced sustainably", so that **consumers together with retailers, development agencies, and policy makers should rather work towards forcing the industry to comply with strict(er) certification rules instead of substituting palm oil with other oils and fats.** The latter requires between 2.5 and 7 times more land for producing the same amount of oil. Furthermore, other monocultures (e.g. cocoa), annual crops (e.g. soy, cotton), or cattle raising—tend to have a worse overall 'sustainability performance' than organically produced palm oil.

From a development perspective, the explicit inclusion of smallholders in organic certification schemes is desired, thus creating an even stronger incentive to boost smallholders' yields through 'ecological intensification', including improved fertilization practices relying on good cover cropping with Pueraria¹. Increased FFB yields are key to boost farmers' profits, increase rural employment, and reduce the pressure for the further expansion of production areas. At the level of mills, most important is to help companies enhance their oil extraction rates to achieve higher profit margins while reducing the environmental damage through palm oil mill effluents (POME). As these cause large quantities of greenhouse gas emissions, certification schemes should ideally force companies to innovate and either use POME to produce electricity (with a biogas plant, burning methane) or for organic fertilizer production (with a good composting).

¹ Pueraria or Kudzu is a leguminous plant that ideally serves as a cover crop in the tropical context, bringing nitrogen from the air into the soil.

Table of contents

Executive summary	i
Table of contents	iii
Acronyms / Glossary	iv
1. Background.....	1
1.1 The rise of palm oil and its global relevance as a key commodity	1
1.2 Increasing awareness about palm oil’s downsides	2
1.3 Coop’s palm oil vision.....	3
1.4 SECO’s interest to promote sustainable palm oil production.....	3
1.5 Project objectives & activities	5
2. Methodology	6
2.1 Procedure & overview of assessed company types	6
2.2 Visual impressions of company types.....	7
2.3 Qualitative assessment approach	9
2.4 Palm Oil Hotspot Analysis	10
3. Assessment Results & Interpretation	12
3.1 General differences among company types	12
3.2 Land Use	14
3.3 Quality Management.....	15
3.4 Social Impact.....	17
3.5 Environmental Impact.....	20
4. Main findings and conclusions	23
4.1 Smallholder farmer involvement is common and feasible –but it requires fairly high company investments to be ideal.....	23
4.2 Good sustainability performance of currently Bio Suisse certified companies – with room for further improvement	25
4.3 From a development perspective, organic & fair palm oil is highly interesting.....	27
5. References.....	30
6. Links to relevant standards.....	32
7. Annexes	33
Annex A Duty rates for crude palm oil in Switzerland.....	33
Annex B Fractions and derivatives of crude palm oil.....	34
Annex C Certification schemes applied by RSPO.....	35
Annex D General palm oil development curve	36
Annex E Process flowchart relating to CPO and PKO production	36
Annex F Brief description of companies involved in the assessment.....	37

Acronyms / Glossary

BOD	Biological Oxygen Demand, which expresses the amount of oxygen needed by aerobic biological organisms to break down organic material present in a given water sample. BOD serves as an indicator for organic water pollution. In palm oil production, it is used to assess POME and to monitor wastewater treatment.
CDE	Centre for Development and Environment. Research unit of the University of Bern tasked to promote sustainability through its inter- and transdisciplinary research.
CHF	Swiss Franc. Swiss currency, where 1 CHF is almost 1 US dollar (early 2019).
CIF	Cost, insurance, freight. Term of sale referring to the price to place goods to a specific port of destination.
CPO	Crude palm oil. Oil produced from the fruit flesh / mesocarp of the palm oil fruits.
DOBI	Deterioration of Bleachability Index (DOBI). This index provides information about the CPO's 'fitness for refining' and quality for food processing. A DOBI of < 2 indicates poor quality; a DOBI > 3 indicates high quality.
ECOWAS	Economic Community of West African States. Union of 15 West African countries committed to economic integration mainly through mutual trade liberalization. Members: Benin, Côte d'Ivoire, Gambia, Ghana, Guinea, Guinea-Bissau, Liberia, Mali, Niger, Nigeria, Senegal, Sierra Leone, Togo, and Burkina Faso.
EFB	Empty fruit bunch (leftover from processed FFB), often used to heat the mill or as organic fertilizer in organic palm oil production systems.
EU	European Union
FiBL	Research Institute of Organic Agriculture
FFA	Free fatty acids, which develop in (over)ripe palm oil fruits through enzymatic hydrolysis in the fatty fruit flesh. Time, temperature and moisture content foster FFA development, i.e. turning the oil rancid.
FFB	Fresh fruit bunch. Harvested oil fruits gathered in fruit stands that can weigh up to 50 kg and can contain up to 1,500 individual palm oil fruits.
FLO	Fairtrade Labelling Organizations, an international umbrella institution that unites 20 labelling initiatives in 21 countries to promote
FOB	Free on board. Term of sale relating to the price that is charged for placing the goods on board a ship at a specific port of departure (i.e. export country).
FPIC	Free prior and informed consent, referring to the principle that a community has the right to give or withhold its consent to proposed projects that may affect the lands they customarily own or use. Common principle used in RSPO certification.

GHG	Greenhouse gases. They absorb and emit radiation within the thermal infrared range causing the so-called greenhouse effect, which leads to global warming or climate change. In palm oil, most critical are CO ₂ emissions relating to deforestation and peat land conversions, plus CH ₄ emissions relating to POME.
HCS	High Carbon Stock. This refers to areas that contain large amounts of carbon, such as forested areas or peat lands. Their conversion to agricultural land releases significant quantities of GHG.
HCV	High Conservation Values. This concept aims at identifying and maintaining biological, ecological, social, or cultural values of critical importance—often linked to high conservation areas (i.e. primary forests, forests near waterways).
ICS	Internal control system, a quality assurance system used in group certification schemes relating to many smallholders that act as suppliers.
IPM	Integrated pest management, relating to an approach that aims at suppressing pest populations below the economic threshold. IPM strategies include measures that hamper the proliferation of pests, e.g. by promoting natural enemies.
LCDs	Least Developed Countries. Countries with low socioeconomic development. As a means to support the development in these countries, LCDs tend to benefit from zero tariffs when exporting to high income countries.
3-MCPD	3-monochloropropane-1,2-diol, an organic chemical compound which is the most common member of chemical food contaminants and suspected to be carcinogenic in humans. In palm oil, it develops during the refining process.
Mini-mill	Small-scale oil processing units at the village level enabling the local population to process locally available FFBs, usually with rudimentary tools. Mini mills are common in West Africa, where service fees are often paid with obtained oil.
NGO	Non-governmental organization
Outgrower	A farmer who has a contractual arrangement with a buying company for the production and commercialization of a certain production. In the context of palm oil, contractual agreements tend to specify FFB quality and price, and access to different services (paid or without cost): access to harvesting equipment, transportation of FFBs, loans to establish plantations, access to inputs.
PKO	Palm kernel oil, produced from crushing and pressing the palm kernels.
POME	Palm oil mill effluents. Liquid waste / contaminated water with oil produced at the level of the mill. POME is treated in a series of digestion ponds to reduce the BOD value and make it safe for release into watercourses (while releasing high quantities of CH ₄ into the atmosphere, unless a biogas plant is in use).
PR	Public Relations, relating to strategic communication efforts to convey key messages to the important organizations and the public.
RDB	Refined, deodorized and bleached (palm oil), which is obtained from CPO at the level of the refinery. RDB oil is commonly used for the manufacturing of margarines, shortenings, frying fats, and ice cream.

RSPO	Roundtable on Sustainable Palm Oil, a membership association founded in 2014 with its own voluntary standard for quality palm oil (www.rspo.org).
SECO	State Secretariat for Economic Affairs, Switzerland
SPOTT	Sustainability Policy Transparency Toolkit, a free, online platform supporting sustainable commodity production and trade: www.spott.org . By tracking transparency, SPOTT incentivises the implementation of corporate best practice.
SWAPP	Sustainable West Africa Palm Oil Programme, a project implemented by the NGO Solidaridad to promote palm oil production among small and medium enterprises aiming to generate important income for rural areas.

I. Background

I.1 The rise of palm oil and its global relevance as a key commodity

In response to the increasing global demand for vegetable oil, the production of palm oil has been extensively promoted. The governments of Malaysia and Indonesia, the largest palm oil producing countries with an 80 % share of the world market, have been particularly active in this regard (Gatto et al, 2017). Palm oil production has more than doubled over the past fifteen years and continues to grow (see Figure 1), already being the most used plant-based oil worldwide, with a share of around 40 % (see Figure 14).

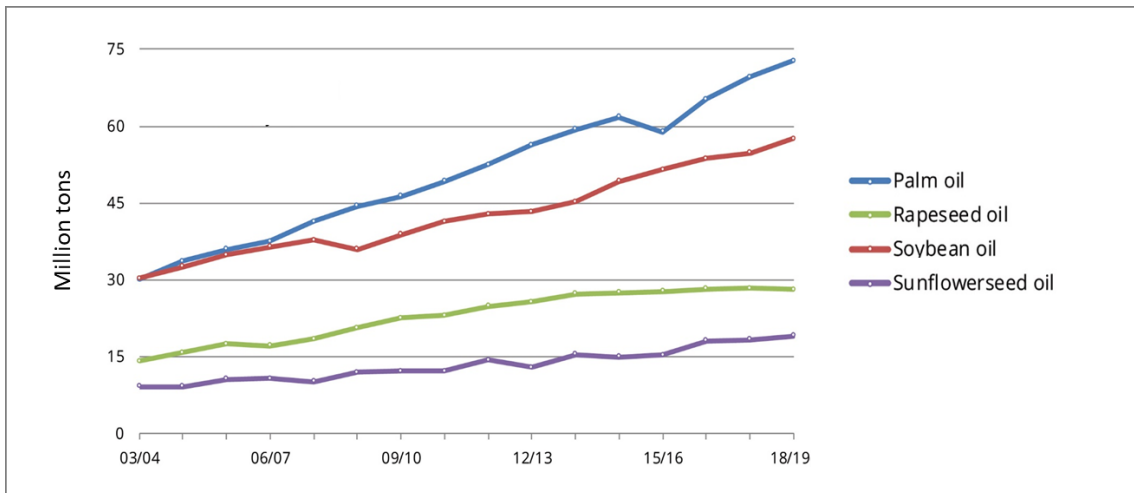

Figure 1 Global Vegetable Oil Production (2003 to 2018)

Source: USDA, AMI

As oil palms are high-yielding, palm oil is cheaper than any competing oil on the world market (see Figure 2). For that reason, India and China have become the biggest importers; together they import palm oil worth more than 10 billion US\$ (Daoui 2019).

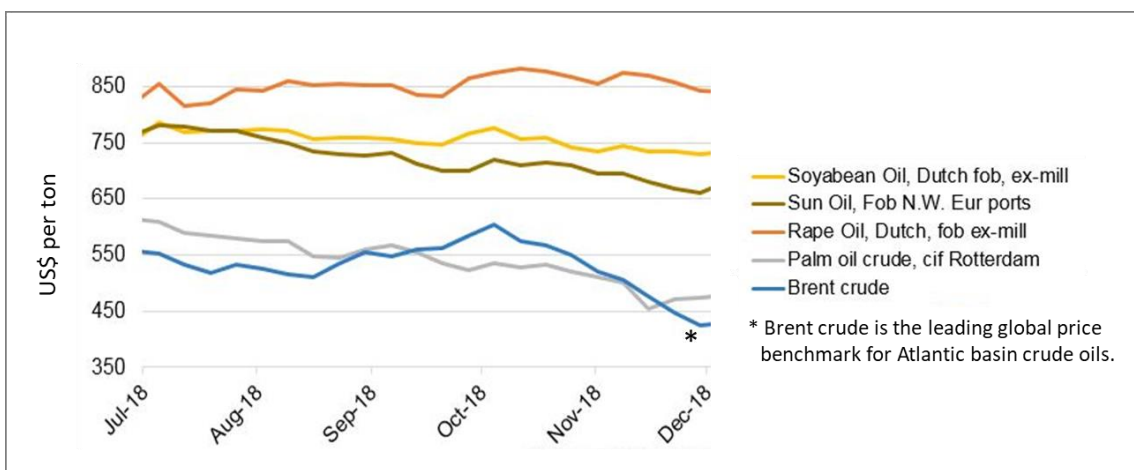

Figure 2 Vegetable Oil Prices in 2018 (July to December)

Source: Based on data from Oilworld (www.oilworld.biz) and ICE

With a price level similar to petroleum (i.e. 'Brent crude' in Figure 2), palm oil has also become attractive as a raw material for biodiesel production, with the EU being a major importer for this purpose.² Yet, imports and consumption levels vary among countries, in line with their tariff systems, with which they protect the production of their own oilseeds (e.g. rapeseed, sunflower seed, soy). In Switzerland, for instance, rather high import tariffs are applied on oilseeds, fats, and oils (see Annex A) mainly to protect its own rapeseed production. Hence, imported palm oil costs about the same as domestically produced rapeseed oil (see Figure 16).

For the food manufacturing industry, palm oil is a highly attractive ingredient, when refined (RBD) and fractionated into stearin and olein (see Annex B). Its neutral taste, heat stability and broad versatility makes it difficult to replace, especially when texture and consistency of the final consumer products must 'melt on the tongue'.

1.2 Increasing awareness about palm oil's downsides

There is increasing evidence that palm oil production—especially when cultivated on big plantations—causes deforestation, biodiversity losses, land tenure conflicts, and other negative environmental and social impacts (Barthel et al. 2018).

In addition, the RSPO Standard has received a lot of critique for not ensuring that RSPO certified companies have a favourable sustainability performance.³ For instance, critics say that the organization and its guidelines have done little to curb deforestation across the world, especially in Indonesia and Malaysia (Barthel et al. 2018); no country on the planet has lost forests at a faster rate over the past century than Indonesia, the country with the largest share of oil palm plantations (Kaye 2017). This correlation between deforestation and RSPO certified palm oil expansion is also scientifically proven by Carlson et al. (2017) for the period 2001-2015.

NGOs criticize that the RSPO lacks the commitment and power to enforce the rules and guidelines it has set forth, and that its procedures to respond to violations by its members are inappropriate (Alexandre et al. 2014). The credibility of the RSPO also tends to suffer from the fact that RSPO certification involves as one option, among others, the mass balance principle, which allows the mixing of RSPO-certified with non-certified, conventional palm oil (see Annex C). This implies that certain companies claim to be RSPO certified while commercializing meaningful amounts of conventional palm oil.

Since 2007, campaigns of consumer-oriented NGOs with international outreach (e.g. Greenpeace, WWF, and OXFAM) have had an important impact on awareness among consumers and government officials about the environmental and social downsides of palm oil production. They blame RSPO and RSPO certified firms to be directly or indirectly involved in promoting environment-damaging practices (Pye 2013). In recent years, consumer awareness was boosted further by mass media and social media channels taking up the 'palm oil story' and conveying it with strong visuals, launching special initiatives and labels for palm oil free products (see Figure 3).

² In 2017, 61% of all palm oil imported into EU countries was used for the production of biofuel, heat and energy; 39% were used for the manufacturing of food, animal feed, and chemical products.

³ In 2017, around 20% of the global palm oil production was RSPO certified (Carlson et al. 2017).



Figure 3 Different palm oil free labels used for food and non-food products

Source: Internet search.

1.3 Coop's palm oil vision

Coop uses around 2'700 t palm oil (2'200 t food, 500 t non-food) to produce around 1'300 own-brand products. As an increasing number of customers and NGOs criticize the use of palm oil, during 2018, Coop did an internal evaluation of the situation relating to around 1'300 own-brand products using palm oil.

This assessment concluded that Coop should take an important step forward, beyond using only RSPO certified palm oil. Therefore, Coop defined a palm oil vision stating the following: "In regard to palm oil, Coop is taking a strictly sustainability-oriented approach and will be using Bio Suisse certified palm oil also in its conventional own-brand food products, or conventional palm oil will be replaced with other oils and fats where feasible from a sensory and technological point of view". Thereby, the following principles were defined, to provide guidance to manufacturing companies and room for innovation in the area of recipe and production development (Schilling 2019):

- Replacement of RSPO/Bio Suisse palm oil with conventional butter/Bio Suisse butter for selected products, if better sensory quality, and if customer expectations and willingness to pay are favourable (e.g. biscuits).
- Replacement of RSPO palm oil with fully hardened rapeseed or sunflower oil for conventional products, if technologically possible and equivalent quality can be obtained (not permitted for organic products).
- Replacement of RSPO palm oil in specific products with fair trade and/or Bio Suisse coconut oil if technologically possible and of equivalent quality (e.g. chocolate eggs).
- Conversion to Bio Suisse palm oil for all other conventional products.
- Sensory quality is the decisive factor in the choice of alternatives.
- For the non-food/near-food sector, RSPO palm oil will continue to be used, as there are currently no feasible alternatives.

1.4 SECO's interest to promote sustainable palm oil production

Nowadays, oil palm cultivation is present in most tropical countries in Asia, Africa, and South America (see Table 1). Even though almost 85 % of the global palm oil is originating in Indonesia and Malaysia, oil palm cultivation is expanding fast in many other countries, where oil palm plantations are still young and production volumes will increase

fast once plantations move into the 'prime stage' (see Annex D)⁴. For SECO, palm oil is of particular importance, from these viewpoints:

- Oil palms are an important crop in many low-income tropical countries (see Table 1), including four of its focus countries – Indonesia, Colombia, Peru, and Ghana – where this crop directly and indirectly generates important job opportunities and income in rural areas.
- Palm oil imports to Switzerland are highly meaningful. Since palm oil competes with fats and oils produced within Switzerland and palm oil production is associated with negative environmental and social impact (see Section 1.2), SECO is eager to contribute to a policy discussion that (a) balances interests of Swiss farmers and manufacturers, and (b) leads to more positive impact of palm oil cultivation in producing countries. This is key in regard to the free trade agreement that is currently negotiated with Indonesia.
- Furthermore, SECO is interested in aligning its palm oil projects with its objective of mainstreaming climate resilience and biodiversity conservation targets.

Table 1 Palm oil producing countries and SECO focus countries (*)

Rank	Country	Production (in 1'000 MT)	Share
1	Indonesia*	41'500	56.47 %
2	Malaysia	20'500	27.90 %
3	Thailand	2'900	3.95 %
4	Colombia*	1'630	2.22 %
5	Nigeria	1'015	1.38 %
6	Guatemala	852	1.16 %
7	Papua New Guinea	630	0.86 %
8	Honduras	580	0.79 %
9	Ecuador	580	0.79 %
10	Brazil	525	0.71 %
11	Ghana*	520	0.71 %
12	Côte D'Ivoire	480	0.65 %
13	Congo	300	0.41 %
14	Costa Rica	270	0.37 %
15	Cameroon	255	0.35 %
16	India	200	0.27 %
17	Peru*	180	0.24 %
18	Mexico	140	0.19 %
19	Philippines	90	0.12 %
20	Angola	60	0.08 %
21	Benin	60	0.08 %
22	Dominican Republic	53	0.07 %
23	Guinea	50	0.07 %
24	Liberia	42	0.06 %
25	Sierra Leone	36	0.05 %
26	Venezuela	15	0.02 %
27	Senegal	14	0.02 %
28	Togo	9	0.01 %
	Total	73'486	100.00 %

Source: [Index mundi](#), 2018.

⁴ Harvesting oil fruits (FFBs) starts after 3-4 years, yet maximal harvests are only reached with 9 years.

1.5 Project objectives & activities

Together with Coop and SECO, a short-term ‘assessment project’ lasting from October 2018 to March 2019. The **overall objective** of this project was to clarify the extent to which organically certified palm oil helps ensure positive ‘sustainability impacts’ compared to palm oil that is produced without any certification or with RSPO certification.

Moreover, to meet Coop’s **specific interest** of identifying potential sourcing partners for Bio Suisse and fair trade certified palm oil, the assessment was linked to a ‘sourcing feasibility check’ of the palm oil producers involved in the study. Concretely, besides the ‘sustainability performance’, FiBL experts assessed also to what extent the companies involved in the study are good existing (i.e. those that are already Bio Suisse certified) or potential sourcing partners (i.e. those without Bio Suisse certification).

Since both Coop and SECO were primarily interested in understanding the palm oil production contexts outside Asia, the assessment focused entirely on countries in **Africa and South America**. In Africa, Ghana was prioritized for testing the assessment methodology, being a focus country of SECO, where palm oil is already being supported.

After the initial assessment of five companies in Ghana, the assessment methodology (see Section 2.4) was reviewed and slightly adapted. Three additional companies, all of them Bio Suisse and RSPO certified, were assessed in Brazil, Colombia, and Madagascar. Project activities included five main areas:

1. **Identification of different organic palm oil producing companies** to be involved in the assessment, including the 3 existing Bio Suisse certified palm oil producers. The 5 companies in Ghana were identified with the support of Solidaridad, the NGO that is implementing the ‘Sustainable West Africa Palm Oil Programme’.
2. **Development of a sound methodology** to assess context-specific effects of different ‘sustainability aspects’.
3. **Assessment of different palm oil companies** in regard to (a) the ‘sustainability performance’ of the prevailing business model and the involved oil palm production system and implemented practices and (b) their capacity to produce interesting volumes and good quality of organic palm oil in the near future for Coop. A special methodology was developed for the assessment of the ‘sustainability performance’ (see Section 2.4).
4. **Documentation of the assessment results** in a final report including conclusions and recommendations that contribute to discussions on the planning of a potential follow-up project.
5. **Project management and communication** that (a) allow an active involvement and interaction of project donors (Coop and SECO) and partners (Bio Suisse and Max Havelaar) as part of an ‘advisory board’, and (b) ensure that the most important project findings are presented and discussed in a broader setup, in the context of Biofach 2019.

The project also aimed at providing insights for Bio Suisse’s revision and development of a new palm oil standard, focusing mainly on two aspects: (a) the definition and involvement of smallholder farmers as providers of fresh fruit bunches (FFBs), and (b) the optimal coverage of sustainability aspects that go beyond current Bio Suisse certification.

2. Methodology

2.1 Procedure & overview of assessed company types

The first mission to Ghana involved three conventional companies with no certification at all, one that is RSPO-certified and one that has organic (EU regulation) and Fair for Life certification. The three Bio Suisse and RSPO certified companies were assessed subsequently, in separate missions involving only one FiBL expert in each case. An overview and short description of each company is available in Annex F.⁵

As companies were promised to treat the obtained information confidentially, four ‘company types’ were defined for the assessment (see Table 2) to show average scores for each company type, but not individual company scores (except where only one company represented a ‘company type’). The definition of these four categories helped to differentiate the assessment results with average findings for each category.

Table 2 Categorization of assessed palm oil company types

Type	Description	Countries
„Conventional“ (N=3)	<ul style="list-style-type: none"> • Rather small companies with their own mill and plantation, and working with outgrowers. Often working also with intermediaries. No certification. • Mills tend to be old and are expanded gradually, implying inefficiencies. • Price of FFBs and CPO are rather low, competing mainly in the national market. Some oil is exported through informal channels to neighbouring countries. • Mini-mills compete for FFB especially in the low season. 	Ghana
„RSPO only“ (N=1)	<ul style="list-style-type: none"> • Medium-sized company with its own mill and plantation, and working with outgrowers. • Competes with other FFB buyers, but outgrowers tend to be faithful because of good services and reasonable price. 	Ghana
„Fair&Organic“ (N=1)	<ul style="list-style-type: none"> • Fair trade focused company with its own mill and sourcing all FFB from small-scale producers (does not have its own plantation). Certified according to Fair for Life and EU Organic. • High CPO price because they offer a specialty product in the international market. Export only. • The company pays a 20 % higher FFB price than other mills in the region. 	Ghana
„BS&RSPO“ (N=3)	<ul style="list-style-type: none"> • Big companies with their own well-managed big plantations, RSPO and Bio Suisse certified. • Favourable outgrower schemes in place. • Big investments into good practices and management. • High price in the export market for the organic produce, but selling also in the national market. • A refinery is commonly part of this business model. 	Brazil, Colombia, Madagascar

⁵ A final company was assessed end of February in Côte d’Ivoire. This company was not included in the assessment results, also because the company involves only a small share of organic (EU Regulation) and RSPO certified produce, which was mainly assessed to judge if this company could qualify to become a future sourcing partner for Coop (see Annex G).

2.2 Visual impressions of company types

A. Pictures illustrating the production situation of “Conventional” companies



B. Pictures illustrating the production situation of the “RSPO only” company

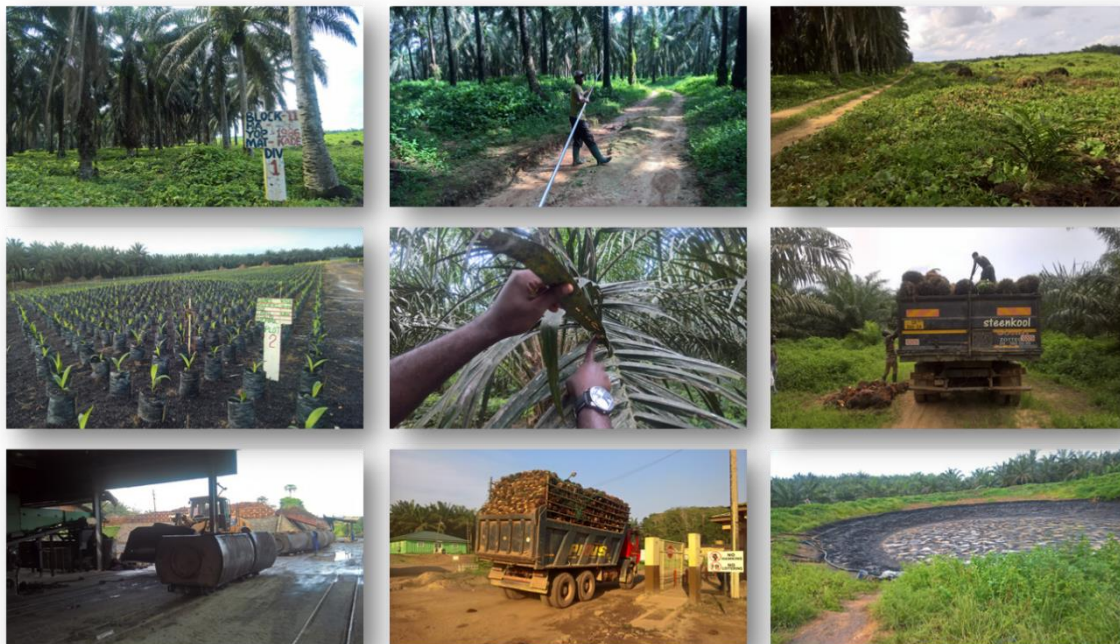

C. Pictures illustrating the production situation of the “Fair&Organic” company

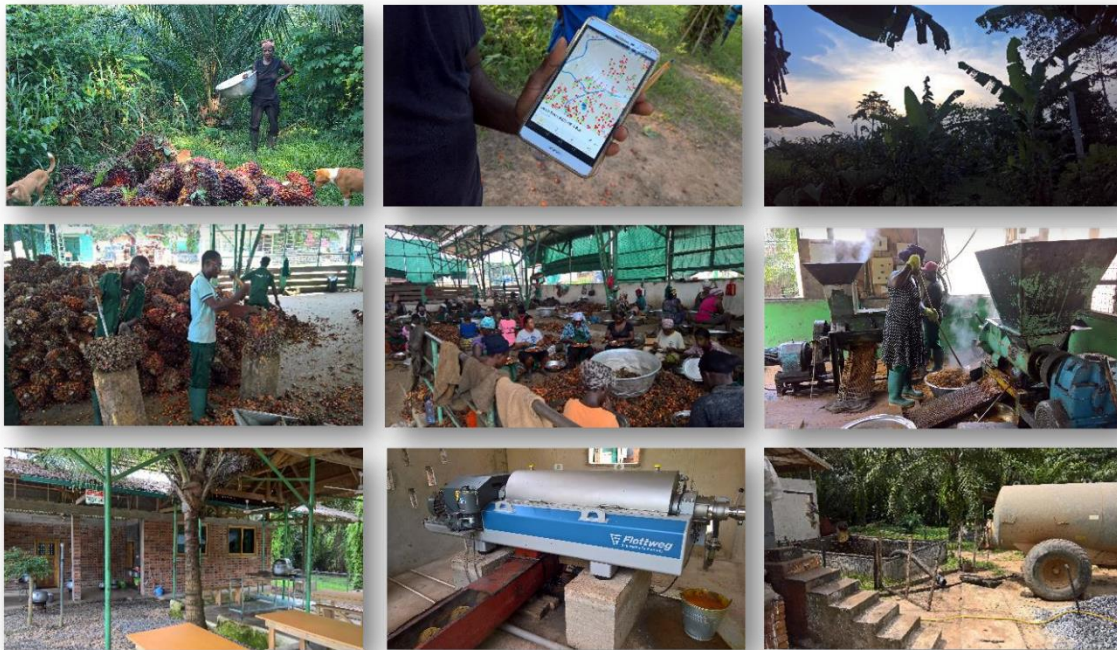

D. Pictures illustrating the production situation of the “BS&RSPO” companies

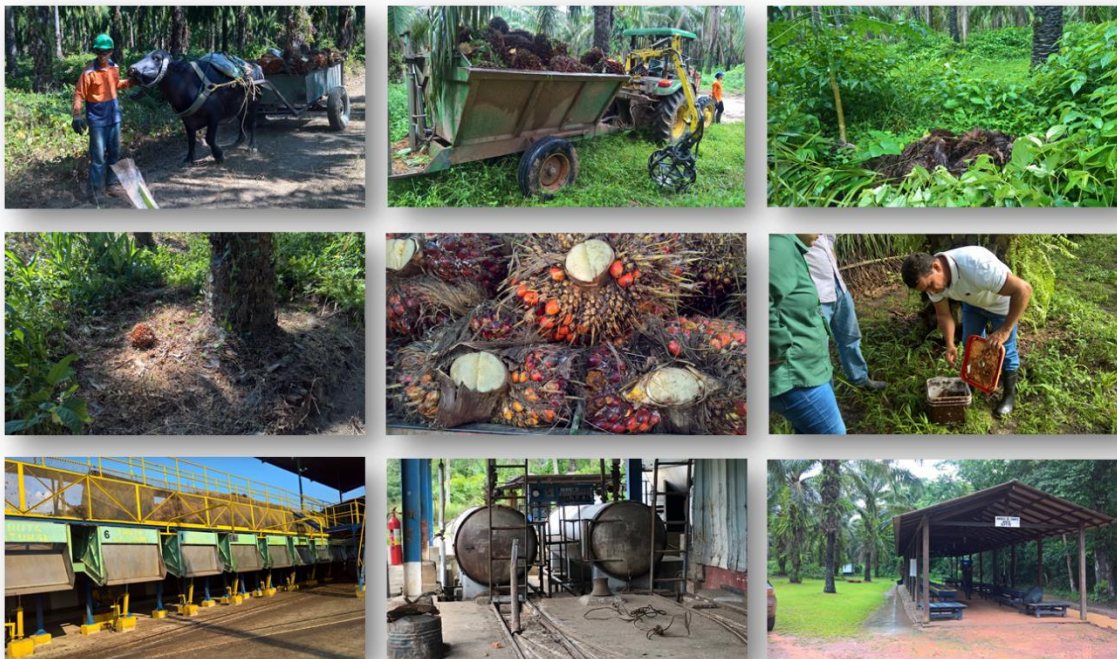

2.3 Qualitative assessment approach

In order to optimize the assessment and minimize time investments from company representatives, each visit was planned to last at most two days. To ensure this, FiBL experts requested certain company information upfront—i.e. company profile with key indicators—to already have a good idea about the business model and size of production in each case (see Figure 4). This information helped also to plan each visit.

Business Type	#	Country	Own Plantation	Contracted farmers	Independent farmers	CPO (t/year)	PKO (t/year)	Comments
„Conventional“	1	Ghana	<input checked="" type="checkbox"/>	<input checked="" type="checkbox"/>	<input checked="" type="checkbox"/>	1200	200	- produce without any certification
	2	Ghana	<input checked="" type="checkbox"/>	<input checked="" type="checkbox"/>		400		
	3	Ghana	<input checked="" type="checkbox"/>	<input checked="" type="checkbox"/>	<input checked="" type="checkbox"/>	4000	630	
„RSPO only“	4	Ghana	<input checked="" type="checkbox"/>	<input checked="" type="checkbox"/>	<input checked="" type="checkbox"/>	18000	2000	- most production RSPO certified, no org.
„Fair&Org“	5	Ghana		<input checked="" type="checkbox"/>		700		- all produce EU org. & fair for life certified
„BSO&RSPO“	6	Madagascar	<input checked="" type="checkbox"/>	<input checked="" type="checkbox"/>		800	120	- all produce with org. & RSPO certification
	7	Brazil	<input checked="" type="checkbox"/>	<input checked="" type="checkbox"/>		11000	1000	- one mill with BS & RSPO certification *
	8	Colombia	<input checked="" type="checkbox"/>	<input checked="" type="checkbox"/>	<input checked="" type="checkbox"/>	29000	6000	- 99% with org. & RSPO certification

Figure 4 Summary of key attributes of the assessed companies

* This company runs 5 additional mills, with an additional volume of 169'000 t of RSPO certified CPO.

Companies were visited with a ‘participatory spirit’ to avoid giving the impression that FiBL experts do an audit. This was important in order to create an environment for a fruitful exchange. In general, the interaction with each company involved the following main steps:

- 1. Revision of company profile information** to establish a good first contact and aiming to fully understand the company’s business logic. This first interaction also helped clarify the objectives of the visit and agree on the detailed program.
- 2. Visit of the mill** to obtain a good first insight into the company’s level of operation, in terms of quantity (processing capacity) and quality (relating to infrastructure, equipment, process logistics, embedded services). The ‘mill tour’ also involved the visit of the weighbridge (to understand product traceability management) and POME basins (to understand the company’s wastewater treatment system).
- 3. Visit of the company’s plantation (if existing)** to gain insight into the company’s practices in regard to oil palm cultivation: plantation design, used varieties, planting practices, maintenance activities, fertilization, harvesting practices and involved logistics, etc.
- 4. Visit of 2-3 outgrowers on their plantation** to understand their way and level of production (see Point 3), and how exactly they are linked to the company/mill.

5. **Implementation of the Hotspot Analysis** (see Section 2.4), as part of a final discussion to reflect on how the company's operations tend to impact different 'sustainability hotspots'. The reflection involves operations of both the company and the FFB suppliers (i.e. outgrowers and independent suppliers).

2.4 Palm Oil Hotspot Analysis

Overall, as FiBL experts strongly relied on the goodwill of companies to provide time and information, the 'assessment exercise' had a reasonable qualitative connotation. To guide the assessment and force FiBL experts to explicitly obtain information for different 'sustainability hotspots', a new methodology was developed for this purpose. With the support of FiBL's socio-economic department, the so-called 'Palm Oil Hotspot Analysis' was developed, involving 22 explicit 'sustainability targets' grouped into four areas (see Figure 5): (A) land use, (B) oil quality, (C) social impact, and (D) environmental impact. The definition of 'sustainability targets' was inspired by existing certification standards and auditing schemes (RSPO, POIG, Bio Suisse) and consolidated during a meeting with project donors and partners.

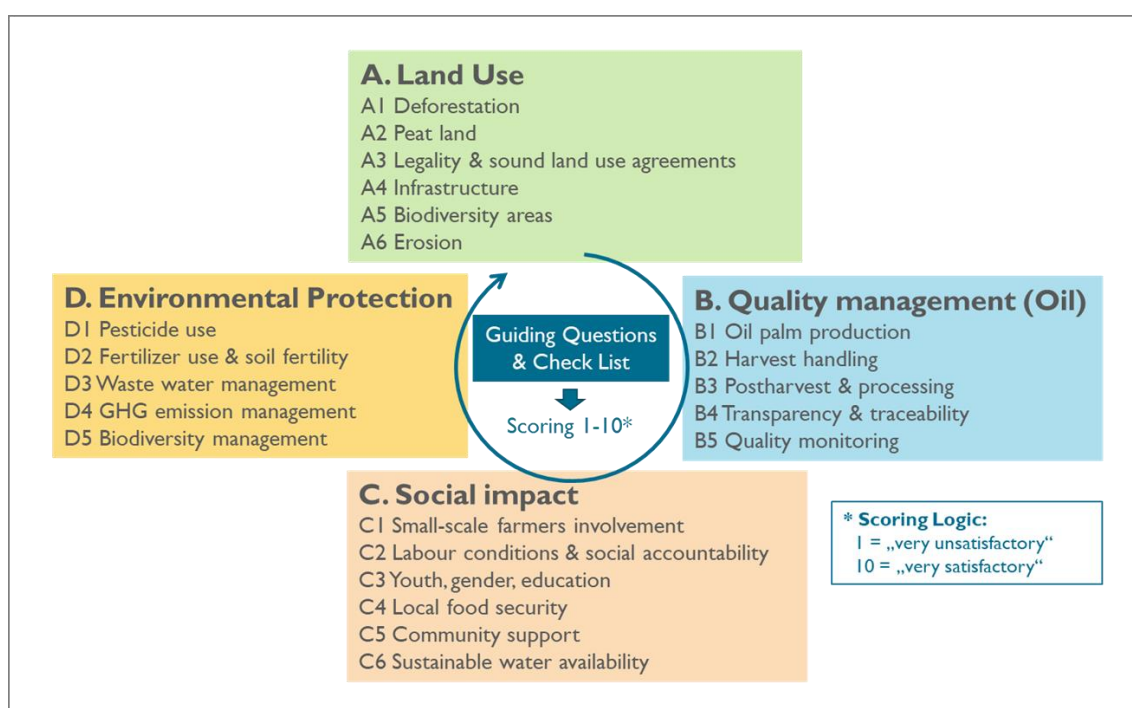

Figure 5 Palm Oil Hotspot Analysis structure, with its 22 sustainability targets grouped into four modules

Source: FiBL elaboration

As a means to guide and focus the discussion when assessing the different 'sustainability targets', the Hotspot Analysis involves a guiding question plus complementary 'check criteria' for each 'sustainability target' to support the flow of the discussion (see Figure 6). The 'assessment session' relied to a great extent on information obtained previously, including the impressions obtained during the mill and plantation visits. At this point, by interacting with company owners or representatives, FiBL experts tried to validate the acquired data and perceptions for each of the different 'hotspots'. Notes were taken on the Excel printouts (see Figure 6) to summarize the most important discussion points.

Later, the two involved FiBL experts applied a scoring to each of the 22 ‘hotspots’ using numbers from 1 (“very unsatisfactory”) to 10 (“very satisfactory”). When sharing and arguing the given scores, a final score was agreed upon and entered directly into the excel file. Once all 22 Excel Sheets were filled in, all scores were pulled together in an overview table, where they could be more easily compared and turned into graphs visualizing the results.

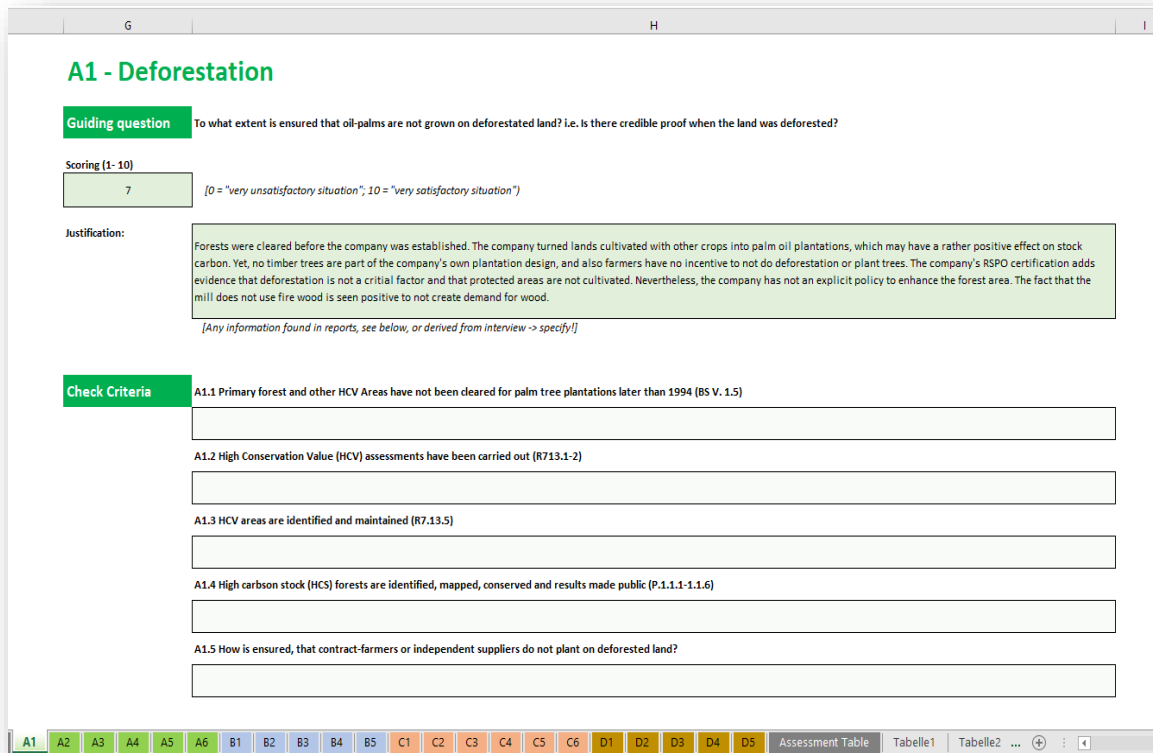

Figure 6 Hotspot Analysis in practice – Excel assessment sheets

Source: FiBL elaboration

The summary table featuring all 22 scores together with a summary text for each score helped identify important differences across companies, i.e. specific aspects that involve better or worse ‘sustainability scoring’.

Finally, with the company categories defined as illustrated in Table, averages were calculated and visualized in a spider diagram (see Figure 7). This visualization is ideal to convey general differences between company types while highlighting relevant differences across specific ‘sustainability hotspots’. By adding a darker shade for “insufficient scores” (1 - 5), and a lighter shade for “not ideal scores” (5 - 7.5), the visualization of scores was enhanced to share assessment findings and derive recommendations for scores that are not “good or very good” (7.5 - 10) (see Figure 7).

3. Assessment Results & Interpretation

3.1 General differences among company types

There are remarkable differences among the company types assessed (see Figure 7). The three Bio Suisse and RSPO certified companies ('BS&RSPO') have the highest overall scores, all in the range of "good & very good". The company certified with EU organic and Fair for Life certification ('Fair&Organic') obtains a similar overall score, with some 'sustainability hotspots' scoring slightly lower—but with 'social hotspots' scoring exceptionally high.

Definitely lowest are the scores of the three conventional companies ('Conventional'), which do not have any certification. The RSPO certified company in the sample ('RSPO only') receives clearly better scores for almost all 'hotspots' than these companies; all scores are beyond "insufficient" but below "good & very good" (see Figure 7).

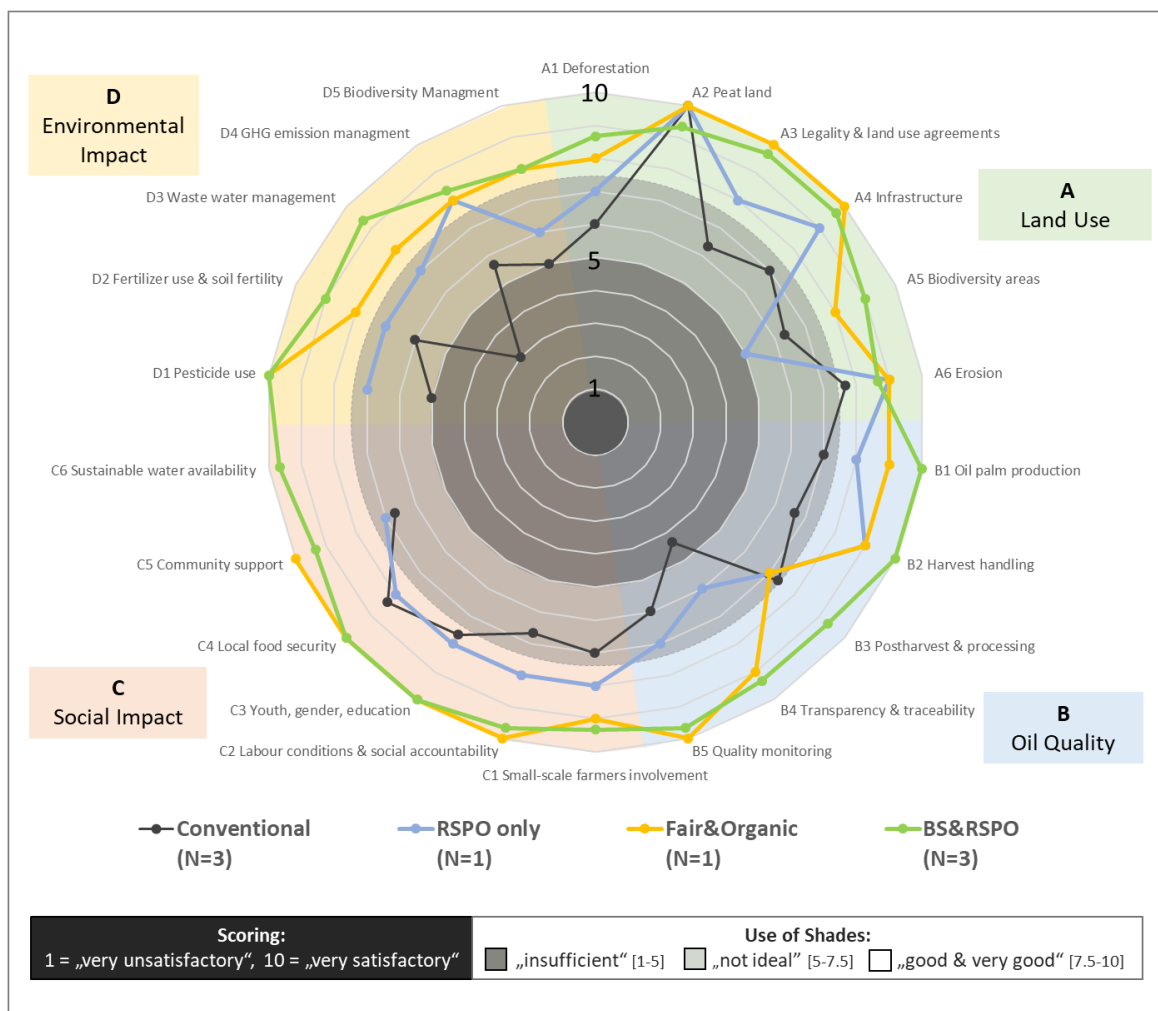

Figure 7 Visualization of all scoring results grouped by company types

Source: FiBL elaboration based on assessment scores.

Reasons and interpretation of these findings:

- All three '**BS&RSPO**' companies are very much committed to the production of high quality palm oil by meeting the Bio Suisse standard and other standards, including RSPO. Being a very rigorous standard and relating to a market that is highly demanding in terms of oil quality, the Bio Suisse standard is, indeed, the key driver for the high scores, especially in regard to 'Environmental Impact' (for relying on ecological production practices) and 'Oil Quality' (for complying with everything needed to supply the very demanding clients in Switzerland). Yet, in this setting, the RSPO standard is clearly adding value to the overall good scoring, as it has a positive influence on different aspects of 'Land Use' and 'Social Impact'. The RSPO requirements on transparency of information (FFB prices, land acquisition, management procedures, etc.) and HCV management (protection of biodiversity areas) are particularly impact enhancing. The solid financial situation of these companies and the higher prices that are obtained with Bio Suisse certified oil allow these companies to implement best practices almost in all areas. The only critical area refers to 'D4' (GHG emission management), where optimal practice involves an expensive biogas plant (costing several million CHF), which is only implemented in one of the three companies involved.
- The overall high scoring of the '**Fair&Organic**' company relates to the use of ecological production practices (i.e. no use of chemicals) linked to a higher CPO price obtained in the market that translates into favourable conditions for both farmers (receiving a 20 % higher FFB price) and workers (good local salaries and insurance coverage). The already good social impact is topped up with different smaller projects funded through the fair trade premiums.
- The low scores of the '**Conventional**' companies are mainly due to their financial constraints to invest in different areas to boost scores. Because of their difficult economic situation—facing strong competition from other mills, including local mini-mills (see glossary)—their investments concentrate on two priorities: FFB sourcing to secure a solid production base to run the CPO mill at an economic level, and upgrading / expanding the mill's infrastructure to increase the processing capacity step-by-step. As the CPO price they obtain in the national market is rather low, their capacity to pay a premium on top of the local FFB price is limited. Nevertheless, they tend to make special efforts to prefinance the establishment of plantations among outgrowers to expand their FFB sourcing⁶. Consequently, companies lack the financial means to invest in areas that are not directly income-relevant, such as wastewater management, biodiversity conservation, and social projects. Because of limited economic resources, they also tend to work with local collectors / intermediaries, which negatively affects 'traceability and transparency' (B4) and 'Land Use', 'Oil Quality', and 'Social Impact' hotspots (see Figure 7).
- The higher overall scores of the '**RSPO only**' company compared to conventional companies can only partly be explained by the RSPO certification. Although the RSPO certification has a clearly positive contribution on different 'hotspots'—e.g. 'legality and land use agreements' (A4), 'labour conditions & social accountability' (C2)—the main driver for a higher scoring of the 'RSPO only' company relates rather to two interlinked key factors: (a) access to investment capital and (b) company size. Both are crucial to reach a business scale that allows the implementation of activities and practices that comply with RSPO rules. As RSPO premiums are low, the CPO price does not cover additional costs implied by RSPO certification. Thus, it is important for these companies to obtain low overall costs through 'economies of scale'. The 'not ideal' scoring in the area of 'Environmental Impact' relates to the fact that RSPO allows—or even promotes—the use of chemical fertilizers and pesticides.

⁶ Oil palms only start producing after the 3rd year after planting, implying that outgrower farmers rely on loans to setup palm oil plantations, to do the required time investment and purchase the seedlings.

3.2 Land Use

The scores for the different ‘hotspots’ relating to ‘Land Use’ vary strongly (see Figure 8). In general, the scores of ‘BS&RSPO’ and ‘Fair&Organic’ companies are in the range of ‘good & very good’. They outperform conventional farms in all ‘hotspots’ except ‘Peat land’ (A2), which is not an issue in the contexts visited: where peat land exists, it is not drained and used for palm cultivation. The ‘RSPO only’ company performs better than conventional companies in almost all criteria, except ‘Biodiversity areas’ (A5).

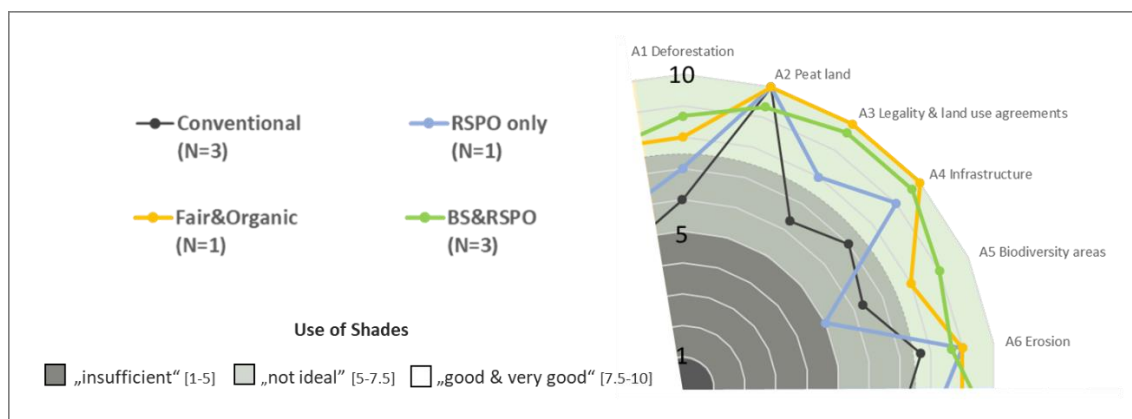

Figure 8 Visualization of ‘Land Use’ scoring results and interpretation

Source: FiBL elaboration based on assessment scores.

Reasons and interpretation of these findings:

- A1 Deforestation** – Forest clearing depends strongly on the specific context. Apart from the Brazilian case, all companies are located in regions where primary forests were cleared decades ago, before oil palm plantations were established. In Brazil, a strict national law requests that companies make substantial forest conservation investments, thus protecting important parts of the primary forest, especially in the Amazon basin⁷. Scoring differences relate mainly to varying practices such as: (a) the protection of secondary forests (including when outgrowers expand their plantations); (b) the use of wood for the mill’s heating system, leading to direct or indirect forest cuttings (often the case in smaller mills), and (c) the direct or indirect promotion of tree growing either near palm oil plantations (e.g. as part of HCV areas or small-scale production structures), or as part of an agro-forestry systems (only one company has started to work with agroforestry systems).
- A2 Peat land** – Assessed companies do not have peat land or land with high ground water levels which they use for palm oil production. RSPO certified companies use such land explicitly as HCV areas. Consequently, the scoring for this ‘hotspot’ is very good.
- A3 Legality & land use agreements** – Country laws and certification schemes (RSPO, Fair for Life, organic) foster good practice in this regard, leading to ‘good & very good’ scores. Overall, especially bigger companies are very cautious when obtaining land titles, being aware that this ‘hotspot’ must be managed well to comply with RSPO certification and to prevent the company’s negative exposure in the media. The lower scores of conventional companies are explained by the fact that they have no influence on how their supplying producers handle this issue, even less so when working with intermediaries.

⁷ The Brazilian law obliges companies to conserve up to 80 % of their land in the Amazon basin.

- **A4 Infrastructure** – All companies tend to have a positive impact on the local infrastructure, benefitting the local population with improved access to roads, electricity, and water. Overall, bigger companies and those committed to fair trade principles have a much higher impact, as they make explicit and substantial investments into upgrading the local education and healthcare infrastructure.
- **A5 Biodiversity areas** – Conventional companies tend to score low for not having any direct benefit when investing into biodiversity areas. Yet, as they source from many dozen small-holders producing FFBs in small plantations, which are often surrounded by natural ‘biodiversity areas’, scores may still be higher than in companies that rely on their big own plantations—even when RSPO certified. RSPO certification does not force companies to set aside a share of their land, but to define land as HCV areas that is not suitable for palm oil cultivation. Organically certified companies have an additional incentive to invest into biodiversity areas, although, also here, there is room for improvement.
- **A6 Erosion** – Among the visited companies, erosion is a very case-specific problem, occurring mainly in steep slopes of palm oil plantations with bare soil due to the use of herbicides. Where a good cover cropping is maintained, for instance with *Pueraria*⁸, erosion may only a problem on dirt access paths and roads, depending on the type of soil that prevails. One BS&RSPO certified company faces erosion problems during the rainy season, when the water volume in streams increases and erodes borders of oil palm plantations.

3.3 Quality Management

The assessment scores for ‘Quality Management’ are especially high for the ‘BS&RSPO’ certified companies (see Figure 9). The scores of the ‘Fair&Organic’ certified company are slightly lower, but still ‘good & very good’. Definitely lower are the scores of the three conventional companies, with ‘not ideal’ scoring relating to all ‘hotspots’.

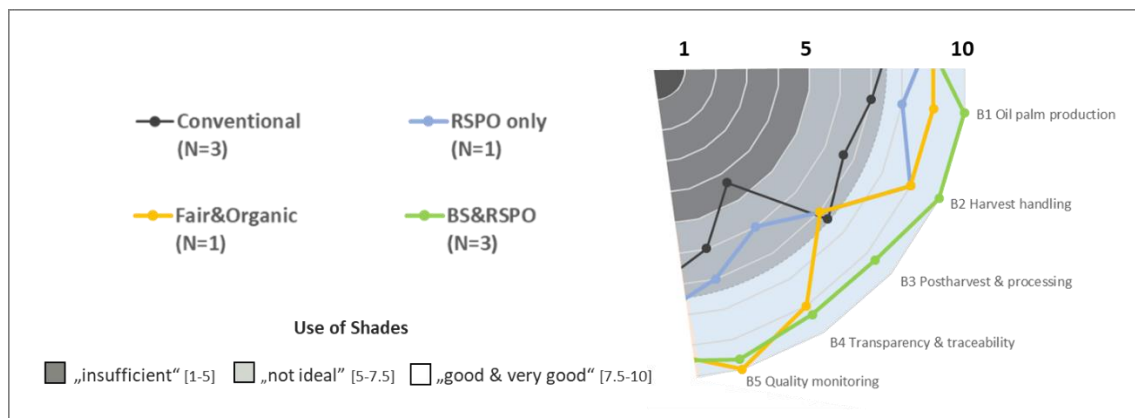

Figure 9 Visualization of ‘Quality Management’ scoring results and interpretation

Source: FiBL elaboration based on assessment scores.

Reasons and interpretation of these findings:

- **B1 Oil palm production** – Best practices in oil palm production are determined by the possibilities of companies to make important investments in this area, for their own plantations and supplying farmers. While the implementation of good practices in their own plantations is

⁸ *Pueraria phaseoloides* is a plant species within the pea family (Fabaceae). It is an excellent cover crop used in the tropics.

rather straightforward, support schemes to promote good oil palm production among supplying farmers requires big efforts to be effective, from a financial and management point of view. For optimal production outcome among outgrowers, companies' extension efforts must be coupled with a 'credit line' and a complete 'service package' to enable to set up and run well-designed farmer-led plantations. Overall, for good production outcome, supplying farmers need access to (a) technical know-how for planting and plantation management, (b) loans to bridge the income gap during the first 3-5 years, (c) different production inputs (e.g. tools, fertilizers), and (d) logistical support to transport harvested FFBs to the mill. While all assessed companies make important efforts to provide such services to farmers, especially conventional farms struggle to cope with this responsibility, because they are facing big. All other companies score 'good & very good', as they have everything in place to guarantee good oil palm production practices within their plantations and among their outgrowers.

- **B2 Harvest handling** – In practice, harvest handling is a key activity. The maturity of the oil fruits when harvested is of critical importance for both CPO yield and quality: ideal are FFBs with a high share of ripe oil fruits and a low FFA content⁹. As good harvesting practices tend to correlate positively with good oil palm production, the companies that have high scores in 'Oil palm production' (B1) also score high here. Harvesters involved in plantations and outgrower farmers are usually very well prepared and equipped¹⁰ for this task. The biggest harvesting challenge is not the harvesting itself but rather sporadic FFB transportation bottlenecks (due to the lack of trucks during the peak season or when heavy rains damage roads), or the company's processing limitations in the high season to handle all harvested FFB in time. In the low season, when fewer FFBs can be harvested, some companies tend to increase the harvesting interval, which implies that a certain share of FFBs is harvested too late, respectively overripe. Nonetheless, to promote good harvesting practices, all companies do an explicit quality check of the FFBs upon delivery to the mill. Companies with a good outgrower scheme have additional strength in making sure, for instance, that the FFB bunches are cut in a way that they have a short stem (optimizing oil pressing).
- **B3 Postharvest & processing** – Overall, the bigger export-oriented companies perform better in postharvest and processing aspects, thus being able to keep FFA levels low in both fruits and CPO. For optimal performance in this area, it is critical that good transportation logistics and sufficient processing capacity are in place to ensure that harvested FFBs are not stored long in the plantation or on 'the ramp' of the mill. Ideally, FFBs should be processed within 48, or even better 24 hours. For those companies that work with independent suppliers (see Figure 4), this is a great challenge. Since the three 'BS&RSPO' certified companies have good logistics and appropriate processing infrastructure in place, scoring is high. In the low season, because of maintenance work at the mill or to optimize processing, certain mills do not operate every day; consequently, FFBs are stored too long at the mill, meaning that FFA content within the oil fruits increases to unfavourable levels. The lower scoring of the 'Fair&Organic' certified company is due to their different processing of FFB: instead of processing FFBs entirely, which is common practice among industrial mills, FFBs are manually separated with an axe in order

⁹ In a fresh ripe fruit, the free fatty acid (FFA) content of the oil is below 0.3 percent. However, as the ripening process advances, with the exocarp getting softer and the fruits detaching themselves from the FFB, the FFA content increases rapidly through hydrolysis. A high FFA content implies a yield loss when converting CPO into RDB oil as part of the refining process. In addition, as higher temperatures must be applied, the 3-MCPD content increases, which lowers the quality of the oil.

¹⁰ The Malaysian Knife is used by all companies assessed. Consisting of a sickle with a long shaft, it is an efficient tool for harvesting FFBs up to 10 meters high.

to later process only the hand-sorted oil fruits (without stem). While creating labour opportunities and income, this procedure implies that the time between harvesting and processing of sorted oil fruits lasts 3 to 4 days.¹¹

- **B4 Transparency & traceability** – Conventional companies' scores in this area are particularly low, due to the large amounts of FFBs sourced via intermediaries, which makes traceability (almost) impossible. Especially when focusing on the export market, bigger companies have a very good traceability system in place; tracking the received FFBs back to the lot (of their own plantation) or supplying producers. Conventional and organic CPO are stored in separate tanks; yet, as companies have no interest to increase the number of oil tanks – i.e. using many small ones rather than a few big ones – traceability is limited: installed CPO tanks gather oil that was produced in a certain time frame, including oil from many different producers and from their own plantation(s). All FFBs supplied daily to the mill are gathered at the ramp and processed together¹². Internal Control Systems (ICS) support the work with supplying farmers in case of organically certified companies, enhancing transparency. By actively and transparently communicating their activities and best practices – as encouraged by the RSPO standard – Organic&RSPO' companies are also able to attract attention among potential buyers, while getting very high scores from SPOTT's palm oil transparency assessment¹³.
- **B5 Quality monitoring** – Assessed companies implement quality monitoring mainly at two levels: (a) at the weighbridge or ramp (i.e. a place where FFBs are stored prior to being processed), where physical quality of FFBs is assessed, and (b) during oil processing, when different oil quality parameters (e.g. extraction rates, FFA levels, purity of oil) are assessed by their own laboratory staff. By targeting the local market only, small companies lack the incentive to do more than needed, measuring mainly impurities, water content, and FFA levels. In contrast, bigger and export-oriented companies are obliged to make considerable oil quality monitoring efforts: they have their own well-equipped laboratory to track the most common oil quality parameters and send samples to specialized laboratories for special parameters (e.g. iodine, peroxide, DOBI). Awareness about the relevance of reducing 3-MCPDs¹⁴ is only present among exporting companies; two 'BS&Organic' companies have concrete projects to eliminate 3-MCPD compounds at the level of their own refineries (i.e. using special biochar).

3.4 Social Impact

The assessed palm oil companies tend to have an overall positive social impact. Only three scores are 'not ideal', all relating to conventional companies; all other scores are 'good & very good' (see Figure 10). The very high scores of 'Fair&Organic' and 'BS&Organic' certified companies are impressive. 'Sustainable water availability' was only

¹¹ As most of the oil from this company is used for soap production, a higher FFA content is not a problem, but rather an advantage.

¹² As FFBs originate year-round from both the companies' own plantations and outgrower areas, separation would be possible (for certification reasons) but would imply important disadvantages: (a) quality decrease of the oil (due to longer storage duration of FFBs, implying an increase of the FFA content in the CPO), (b) higher processing and oil costs (due to the need to expand the ramp for separate storage and 'flush the mill' as part of separated processing).

¹³ The two 'BS&Organic' companies involved in this assessment, Daabon and Agropalma, rank both among the top three in this list, with a scoring of over 90 % (see www.spott.org).

¹⁴ 3-MCPD compounds develop in the CPO refining process, as part of the bleaching process. As 3-MCPD levels in the RBD oil correlate with FFA content in the CPO, it is most important to obtain low FFA levels through optimal production, harvesting and postharvest management.

scored for the three 'BS&Organic' companies because this criterion was added after the first mission to Ghana.

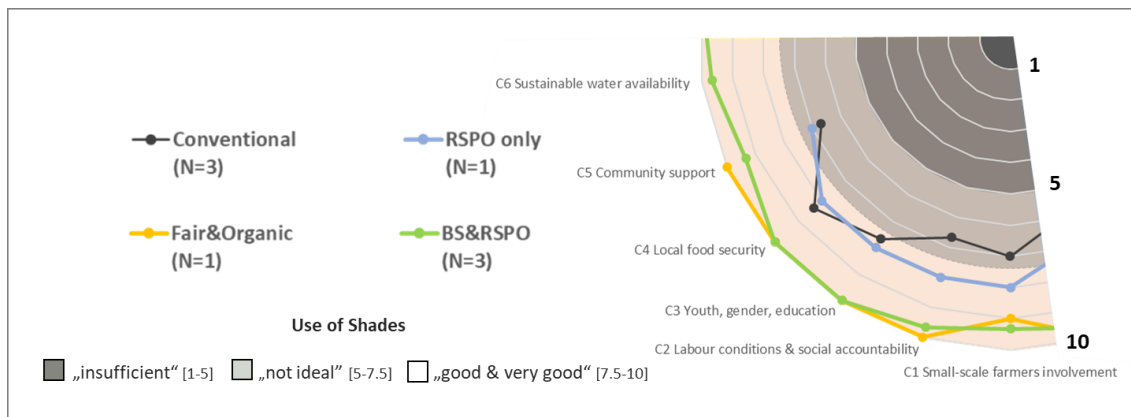

Figure 10 Visualization of 'Social Impact' scoring results and interpretation

Source: FiBL elaboration based on assessment scores.

Reasons and interpretation of these findings:

- C1 Small-scale involvement** – The involvement of local farmers as FFB suppliers is common among all assessed companies (see Figure 4). Access to additional FFBs, besides those sourced from their own plantations, helps capitalize the company's processing infrastructure, respectively increase the mill's operation capacity. Since this is even more important for smaller mills, which are lacking the financial resources to have their own big plantations, they source especially high shares from supplying farmers and thus create important income for their suppliers. Yet, the quality of small-scale farmer involvement is strongly driven by companies' capacity to engage with farmers in a way that they are part of an effective cooperation / outgrower scheme that includes tangible services and benefits for farmers (see B1 above). As 'conventional' companies have less possibilities to pay an attractive FFB price and provide a full range of support services, and of good quality, their scoring is slightly lower than the one relating to the 'RSPO only' company. In contrast, the organically certified companies obtain very high scores because they have effective outgrower programs with very good service quality. They also pay good FFB prices to their suppliers (including premiums for organic). Moreover, the purpose of the internal control system (ICS) used for group certification is also to optimize the companies' extension efforts for the involved smallholder groups.
- C2 Labour conditions & social accountability** – Certified companies (fair, organic, RSPO) are compelled to create good working conditions for both their own company workers and outgrowers. While fair trade certification is very explicit about creating optimal labour conditions to outgrowers and paying good FFB prices, RSPO audits ensure that social accountability principles are implemented at the level of the company itself, the service providers, and the supplying farmers. Yet, as this implies minimal wages and social security payments, conventional mills tend to outsource such responsibilities when involving service providers or intermediaries. 'Conventional' companies tend to pay FFB prices that relate to average prices applied in the region, i.e. which may not cover a living wage, especially when yield levels of supplying farmers are low.
- C3 Youth, gender, education** – All palm oil companies create relevant jobs and income opportunities in rural areas, also for young people. In general, oil palm cultivation and CPO production create a differentiated labour demand for men and women. Men engage in harvesting and slashing; especially in Africa, women are involved in the collection of loose oil palm fruits

and FFB carrying. Especially interesting jobs for young people are created directly at the level of the mill, relating to CPO and PKO processing (mainly men) plus administration (mainly women); indirect jobs are created in construction works (mill, roads, housing) and service provision. Clearly, bigger companies have a bigger employment impact for the areas where their mills are located. This is also true in regard to education, where bigger companies often donate funds to support local schools and student education, or finance education for their own staff. Overall, small 'conventional' mills are too financially constrained to make such extra investments in favour of the local community.

- **C4 Local food security** – All palm oil companies have a positive influence on local food security. They generate important (additional) income for farmers and workers, which is used for food purchase, while both tend to grow annual and seasonal crops for home consumption. In the assessed contexts, land does not seem to be a limiting factor: enough space is available to grow oil palms and food crops in parallel. When palm oil plantations are still young (less than four years), smallholder farmers also plant annual food crops between the rows of oil palms. The maximum scoring of the 'BS&Organic' and 'Fair&Organic' companies is explained by the extra efforts these companies make to improve the nutritional status particularly of their workers, their supplying farmers, and their families. Measures include the provision of subsidized food of good quality in their canteens, raising awareness among workers on the importance of good nutrition, and special community projects promoting vegetable gardening as a means to promote healthier consumption. These efforts are commonly complemented with improved access to medical services, which also contributes to the improvement of the nutritional status of the local population.
- **C5 Community support** – Small conventional companies have limited financial possibilities and incentives to do community support beyond hiring locals for the mill and buying FFB from farmers. Bigger companies share the concern to support the livelihoods in the surrounding communities, but actions vary: certain companies make important direct investments to support educational facilities or local infrastructure (e.g. road improvements, bridge building, and installation of water pumps); others aim to strengthen the capacity of local governments to deliver public services and infrastructure. For the company certified 'Fair&Organic', fair trade premiums are a key mechanism to avail community support with a participatory and demand-oriented approach. Moreover, the RSPO standard encourages companies to communicate transparently which activities are implemented to support local communities.
- **C6 Sustainable water availability** – This criterion was included later, so only the three 'BS&RSPO' certified companies were scored in this regard. In their case, water availability for the surrounding communities is fully ensured, as sufficient water is available and companies carefully clean and dispose their wastewater (POME). In South America, national laws tend to favour local communities, aiming to ensure water access and to protect their water rights. In any case, as water grabbing is a hot issue in both local and international media, bigger companies have a clear incentive to manage this issue very carefully in order to protect their reputation. Retrospectively, it seems that also in Ghana, where this criterion was not assessed, 'sustainable water availability' is not a critical issue, as there is no water scarcity in the production area (i.e. there is enough rainfall, and oil palm growers do not irrigate). Yet, potential contamination of water through POME may locally be an important concern, i.e. when wastewater treatment is not implemented adequately, being mostly the case in conventional farms (see D3 below).

3.5 Environmental Impact

Environmental scores, particularly wastewater management (D3), are especially low for ‘conventional’ companies (see Figure 11). Scores for the ‘RSPO only’ company are clearly higher, but only those from the ‘BS&Organic’ companies are ‘good & very good’.

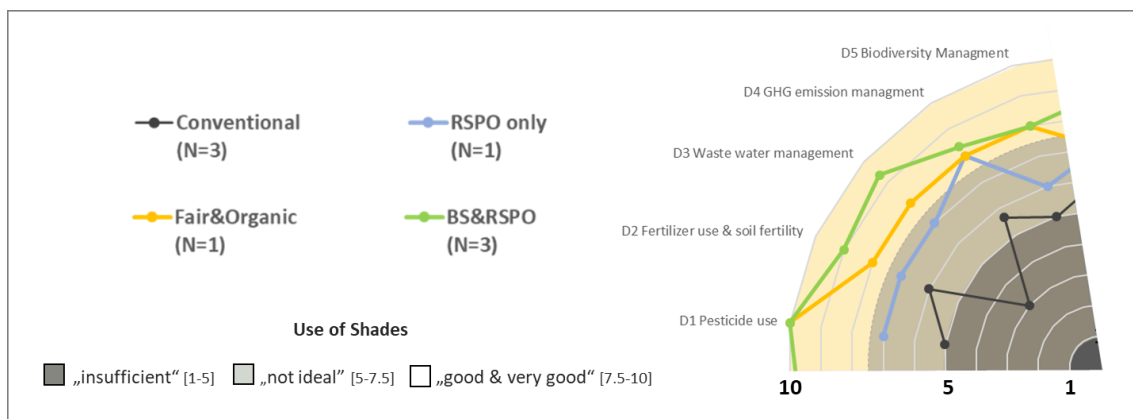

Figure 11 Visualization of ‘Environmental Impact’ scoring results and interpretation

Source: FiBL elaboration based on assessment scores.

Reasons and interpretation of these findings:

- D1 Pesticide use** – Pest and disease pressure is low in all contexts: both are commonly controlled without chemicals. In organically certified companies, no chemicals are used at all; occasionally, biological control agents are applied to fight pests, and weed control is done by slashing only (i.e. no use of herbicides). In contrast, non-organic companies and their outgrowers often use herbicides to control the vegetation under the oil palms. The most common herbicide is Glyphosate. In Ghana, in rare cases, the highly toxic Paraquat is still applied. RSPO certification promotes ‘good practices’ in the use of pesticides. This has varying implications. On the one hand, herbicide use is promoted as part of ‘best practice’, leading in some cases to a situation where outgrower farmers tend to keep their plantations clean from weed by using abundant amounts of herbicides. On the other hand, because of the instructions to use a protection gear when applying herbicides, certain outgrower farmers stay away from such chemical treatments, thus doing the weeding only manually by slashing.
- D2 Fertilizer use & soil fertility** – Depending on the certification scheme, there are important differences on how palm trees are fertilized. In non-organic production, the use of mineral fertilizers is common. In organically managed plantations, where the use of these chemical fertilizers is prohibited, important investments are undertaken to bring organic inputs into the plantations, including mainly EFBs, press fibre, rock phosphate, POME, and ashes (from the mill’s heating system). Due to the companies’ interests to boost especially their own yields, their own plantations are often prioritized when it comes to organic fertilization. One important problem is that EFBs and POME are bulky and thus imply good equipment and high transportation costs when being transported to plantations of distant outgrowers. Cover cropping with Pueraria/Kudzu¹⁵ is promoted as best practice in both organic and conventional production systems. However, the special investment required to purchase Pueraria seeds and

¹⁵ Pueraria, a leguminous plant, is able to fix nitrogen from the air and bring it to the soil (up to 150 kg N/ha). When promoted through sound management practices (not deep and frequent slashing), Pueraria is also highly effective to prevent erosion, increase soil moisture and soil fertility. Its deep taproots also transfer valuable minerals from the subsoil to the topsoil.

inappropriate weed management (including the use of herbicides) often cause a rather poor cover cropping in those plantations that are linked to companies that are financially constrained and lack expertise in this field. In contrast, big companies hire special experts for this task, being aware that fertilization—in both organic and non-organic farms—is a critical production factor: FFB yields very much depend on the amount of nutrients made available to oil palms. Thus, big farms elaborate explicit fertilization plans for their plantations, taking into consideration, the age of the plantation, soil analysis data, and yield targets. Nonetheless, compost is used only in one of the four organically certified companies assessed, relying on adequate space, equipment, and know-how.

- **D3 Waste water management** – POME treatment is a highly critical issue. It relates directly to the production of GHG emissions (see D4) while involving a high risk of water contamination when not done correctly. All certified companies (RSPO/Organic/Fair) take the wastewater management issue seriously, having an appropriate POME management in place. They mostly use different open ponds to depurate the water naturally¹⁶, or apply POME as liquid fertilizer in plantations. In contrast, ‘conventional’ companies do not invest into sound POME management; they may have smaller ponds in place, but these are not well managed or are too small, so that a big share of their wastewater contaminates local water sources (e.g. ponds and rivers). A stricter national law, or rather a good enforcement of it, would be key to help prevent such poor POME management.
- **D4 GHG emission management** – GHG emissions of palm oil production comes from various sources. Most important are land use changes when primary forests, old secondary forests, or peat lands are converted into oil palm plantations. Yet, still highly relevant are GHG emission caused by POME, as big quantities of methane are released into the atmosphere¹⁷—unless a biogas plant is in place (Chase & Henson 2010). Only one company has such a biogas plant in place, one of the three certified ‘Organic&RSPO’, due to the fact that an investment of several million dollars and considerable know-how is required to set it in place. Besides installing a biogas plant, which has the big advantage to produce big quantities of electricity, other options exist to reduce methane emissions, including: skimming and pressing of POME to actively separate the oily share and use it as resource for outside biogas plants, fuel, or as a component for composting. At the level of the mill, GHG emissions are caused by the use of firewood as part of the mill’s heating system, which is very common in smaller mills.
- **D5 Biodiversity management** – In just about all companies and their supplying farmers that were visited during this project, oil palms are produced in monocultures. In such production systems, plant diversity is low, even more so when Pueraria is well established as a cover crop, or when herbicides are used to keep the plantation weed-free. As organic production relates in most cases also to monocultures, above ground, organic production does not seem to involve a much higher diversity. Yet, below ground, the presence of microorganisms is likely to be bigger than in conventional systems. Especially where EFBs are brought back to oil palm plantations, a highly meaningful decomposition of organic matter takes place. In general, companies do not have an explicit ‘biodiversity strategy’, and no real economic incentives to invest into general biodiversity promotion. Selectively, ‘BS&RSPO’ certified companies foster

¹⁶ POME is led into a series of subsequent ponds to increase the surface and thus contact with the atmosphere, allowing decomposition (and high CH₄ emissions!) of soluble and deposition of non-soluble organic compounds. Oil residues in the POME float to the surface from where they can be skimmed off and used for the production of soap. Deposits can be used for fertilization. Once the BOD is low enough, in the last pond, the treated water can be released into water bodies without risking eutrophication.

¹⁷ Per ton of FFB, 20 m³ of methane are produced, which translates into 460 kg of CO₂ eq.

special plant species and beneficial insects as part of their IPM strategy. RSPO certified companies focus mainly on setting aside explicit, already existing, biodiversity areas (i.e. HCV areas), with the aim to protect and monitor them as part of 'biodiversity management'. Only one big company uses intercropping ('BS&RSPO') and another company ('Fair&Organic') has just started with a few agroforestry plots to study more diverse production systems that include timber and fruit trees besides annual crops and green manure species. From a diversity point of view, it is also meaningful that many outgrowers tend to intercrop the young oil palm plantations with annual crops or fruit trees (e.g. papaya, banana, citrus). From a landscape perspective, small-scale farmers tend to involve more plant diversity at a bigger scale, given the fact that their plantations are not so big compared to the ones of big farms, thus involving also other crops and unused land stripes, which both increase plant diversity. Introduction of animals as part of production system management is not practiced among the assessed companies and their outgrowers, except some 'wild chicken' searching for food inside oil palm plantations.

4. Main findings and conclusions

4.1 Smallholder farmer involvement is common and feasible—but it requires fairly high company investments to be ideal

Even though most companies have their own palm oil plantation, the involvement of independent and contracted farmers to increase the FFB supply base is common. For all assessed oil mills, individual or grouped farmers play an important role as FFB suppliers. Although the FFB share is lower in big companies, the absolute volume of FFB obtained from local farmers, with thousands of tons per year, is considerable and highly meaningful in terms of income generation in the rural context (see Figure 12).

Business Type	Farm	Country	Own plantation (FFB t/year)	Contracted farmers (FFB t/year)	Independent farmers (FFB t/year)	Intermediaries (FFB t/year)	Share of FFB from farmers (incl. FFB from intermediaries)
„Conventional“	1	Ghana	157	2251	3842	1050	97.8%
	2	Ghana	500	1875			78.9%
	3	Ghana	2227	1051	1413	6755	80.5%
„RSPO only“	4	Ghana	48000	905	37000		44.1%
„Fair&Organic“	5	Ghana		5000			100%
„BSO&RSPO“	6	Madagascar	4500	(planned)			0%
	7	Brazil*	670000	215741			24.4%
	8	Colombia**	107000	45000			29.6%

Figure 12 Summary of FFB sourcing among the assessed companies

* All production, of all 6 mills. None of the contracted farmers are currently producing organic; among them are 192 family farms which cultivate palm oil on own land from 4 ha to 12 ha.

** All own production has RSPO & organic certification. From contracted farmers, 80% is RSPO and organically certified (=35'000 t FFB/year); from these 70% relate to small holders (=25'000 t FFB/year).

Although certain mills rely to 100 % on a smallholder outgrower scheme, this business model is rather unique when linked to an export venture. It is more common for companies to have their own plantation. First, the plantation helps secure a solid self-production to supply the mill; second, it provides an excellent primary investment to have all the required capacities and services in place to expand the FFB sourcing through a successful outgrower scheme. Supplying farmers belong to two different categories:

- **Contracted farmers** are structurally and contractually bound to a specific mill. Unless they are bigger farms, they are usually part of the company's 'outgrower scheme' through which they are supported in various ways, most commonly via support in the area of training in good management practices, access to loans (e.g.

for plantation setup, planting material, fertilizer inputs), and support in providing harvesting tools and logistics for harvested FFBs. As a rule, the mill organises and pays for certifications. Since the company is the certificate owner in this case, the entrepreneurial freedom of contracted farmers is limited.

- **Independent farmers** can, but do not have to supply their FFBs to a particular mill. As a rule, independent farmers receive neither financial nor technical support from the purchasing mill. Collection and transport to the mill are often organised by intermediaries or by the farmers themselves. Once the mill is charged at full capacity, which is often the case during high season among smaller mills, FFBs from independent smallholders are usually rejected.

Conclusions to enhance economic and sustainability performance

Our findings show that from both an economic and sustainability perspective, the most interesting business models are those where palm oil companies involve both their own plantation and a ‘sophisticated’ outgrower scheme to source at the same time from local farmers. Such a ‘twin strategy’ has clear advantages:

- **Company's own plantation** – Having their own oil palm plantation provides the companies essentially secure access to a minimal amount of FFB to run their own mill economically and with low risk. At the same time, having their own plantations helps the companies ensure that all essential assets are in place – production-related know-how, transport logistics, and other services (e.g. access to seedlings, soil analysis etc.) – to then also build up and run a successful outgrower scheme.
- **Outgrower scheme** – An outgrower scheme essentially capitalizes the company’s investments relating to mill infrastructure, transport logistics, production and processing, and administration. In addition, outgrower schemes help reducing further investment costs as FFBs can be sourced from land that does not have to be owned or rented. Ultimately, outgrower schemes are relevant for a company’s image. Especially for big companies, well-implemented outgrower schemes are highly effective in helping the region where the mill is located.

Nevertheless, assessment results clearly show that successful, well-run outgrower schemes come with a cost! Time investments can be considerable to set them up and partnership agreements remain risky if FFB prices paid and services provided to farmers are not generating benefits for involved farmers¹⁸.

Overall, successful engagement with outgrower farmers requires access to a company that pays good CPO prices while keeping production costs low thanks to ‘economies of scale’. This enables them to pay good FFB prices to farmers and to offer a range of highly relevant services. Organic production tends to offer such a context, with the main challenge to help ensure outgrowers access to good quality organic manure to complement Pueraria cover cropping. This is currently not well implemented in all assessed organically certified companies. An improved organic fertilization of farmers’ oil palms will also help increasing considerable FFB yields and the share of FFB provided by farmers.

¹⁸ Risks and costs tend to be higher the smaller the farms are. When full-farm conversion applies with farms that also grow crops where pesticide use is common (e.g. cocoa), risks are even higher.

4.2 Good sustainability performance of currently Bio Suisse certified companies—with room for further improvement

Assessment scores for the three Bio Suisse certified companies are ‘good’ and ‘very good’, with an average across all scores of 9.4 out of 10 (see Figure 7). There are different reasons contributing to such overall good ‘sustainability performance’:

- **Professionally led companies with a solid investment base and good outreach** – All Bio Suisse certified companies have persons and management structures in place that essentially make their operations successful with the available financial means. Good management and investments include a wide range of activities and business units: company leadership and communication, company-own plantations and outgrower schemes (see 4.1), service provision and handling of inputs, processing and trading, social support activities. The size of the companies and the mills’ turnover allow hiring experts in different fields, which is key to work at such a high professional level.
- **Bio Suisse certification and high(er) CPO prices** – Organic certification triggers high ‘Environmental Impact’ scores by not using any kind of pesticides and mineral fertilizers. From an organizational point of view, the ICS is a key asset for good outgrower scheme management and monitoring, also providing important leverage for extension activities among smallholder groups. The prices fetched thanks to organic certification, together with economies of scale (to keep average production costs low) allow improvements in different areas. Most importantly, the organic premium translates into higher FFB prices paid to supplying farmers, which is key to insure a good cooperation with them (i.e. complying with all aspects of the organic regulation and communicating well). At the same time, high(er) CPO prices allow the company to put high quality outgrower services and other activities in place that benefit both farmers and the local population.
- **RSPO certification** – RSPO certification generates a clear added value for organically certified companies as it covers different relevant sustainability aspects that are not or not well covered by the organic regulation, including the monitoring of conservation areas, labour and land rights, and social impact (see Figure 19). In addition, the proactive and transparent sharing of information promoted by the RSPO standard is a clear added value for companies. It has helped these companies to position themselves as ‘sustainability leaders’ in the palm oil sector at the global level, and develop and maintain a good reputation within their countries and among their clients. With their transparent communication (‘open door policy’), they also stimulate interaction within the palm oil sector and foster continuous learning among their staff, thus further improving the company’s performance.

Despite the good overall scores, there are different aspects where there is room for further improvement for these companies, as illustrated in Figure 13.

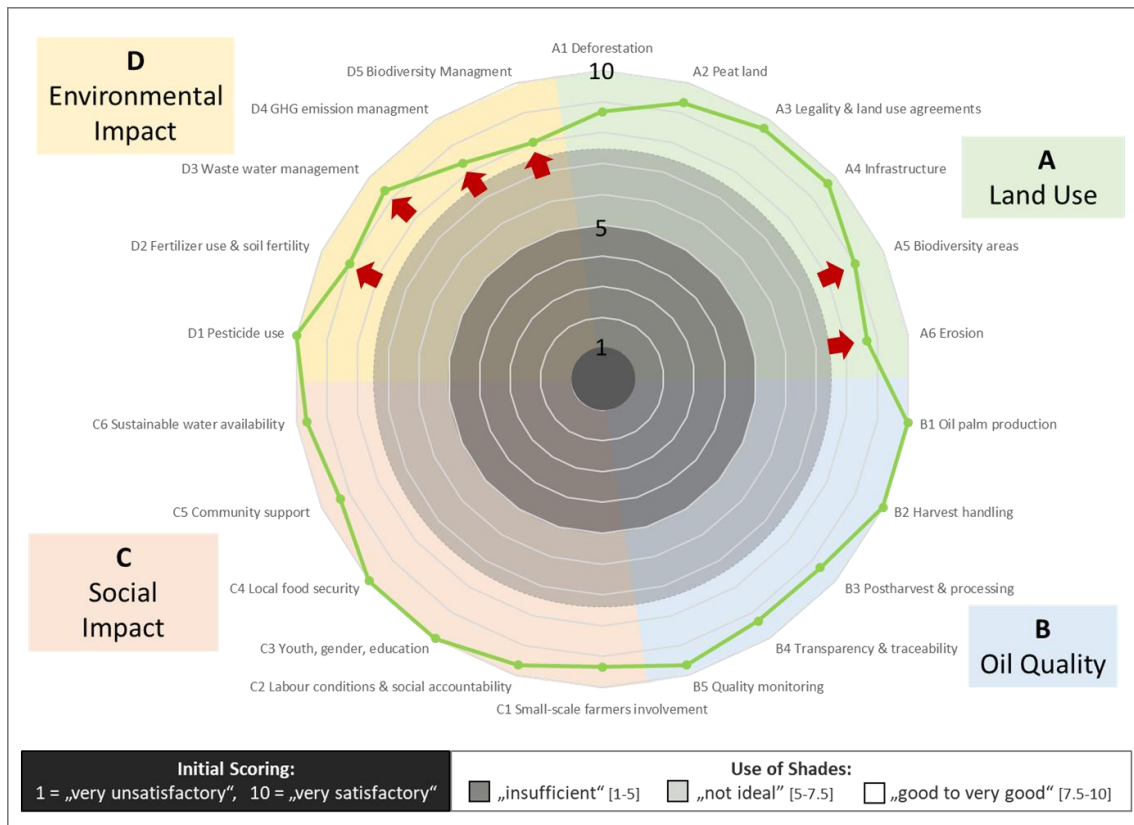

Figure 13 Assessment scores of ‘BS&RSPO’ companies with areas of improvement

Source: FiBL elaboration based on assessment scores.

Relevant areas to further improve the sustainability performance:

- **GHG management (D4, D3)** – A biogas plant is only implemented in one of the three ‘BS&RSPO’ certified companies as part of POME treatment; thus, the other two companies have important potential here for reducing their methane emissions. Although a biogas plant is by far the best and most interesting technology, other (cheaper) alternatives may be considered, including composting and technologies that separate POME solids and oil residues from the water, so that the solids can be used as an organic fertilizer component and POME in fertigation, as a liquid fertilizer.
- **Fertilization management (D2)** – Good fertilization practices are key to obtain good FFB yields. While on the companies’ plantations fertility management is at a very high level, fertilization practices among outgrowers have room for improvement, particularly where bulky organic material is used (i.e. EFBs) and farmers’ plots are distant. A meaningful step forward would be consequent efforts to implement optimal Pueraria cover cropping complemented with the production of a good quality compost near the mill—involving shredded EFBs, fibre, ashes, and POME. Such compost would allow simpler fertilizer applications for outgrower farmers and help increase FFB yields¹⁹, which are key for good profitability.
- **Biodiversity management (D5, A5, A6)** – Efforts of ‘BS&RSPO’ certified companies focus on setting aside and protecting HCV areas, and on monitoring flora and fauna in these areas. This is already good practice considering that these companies have no economic incentives to invest into ‘proactive biodiversity management’, since biodiversity areas tend to reduce the land

¹⁹ Different outgrowers that were visited as part of the assessment comment yield levels of around 6-8 tons of FFB per ha. With good (organic) fertilization, yields can be at least twice as high.

available for oil palm planting. Thus, creating such incentives and helping companies to optimize biodiversity outcomes without high investments or costs is key. Most important are incentives or support measures for establishing effective buffer zones towards neighbouring plots, along roads and water streams, ideally linking them with primary and secondary forests as part of a landscape approach. Potentially, such buffer zones also help to prevent erosion²⁰. At the same time, diversity could tangibly be improved by the introduction of well-designed agroforestry systems and subdivision of large plots with species-diverse corridors.

4.3 From a development perspective, organic & fair palm oil is highly interesting

The overall good to very good ‘sustainability scoring’ for the ‘BS&RSPO’ certified companies leads not only to the conclusion that “*yes, palm oil can be produced sustainably*”, but also that important social impact is generated through palm oil production. The very high scoring of organic & fair certified companies in regard to ‘Social Impact’ (see Figure 7) implies that palm oil production is, indeed, a viable way forward in promoting development in tropical rural areas—if produced with organic and fair trade principles!

Thereby, different aspects are relevant:

- **Oil mills are important ‘development motors’ in rural areas** – Worldwide, palm oil production creates important opportunities for the local population in poor rural areas, where job and income opportunities are limited, and young people tend to migrate to urban areas. Palm oil companies create jobs at the level of mills and generate tangible demand for a variety of services. Furthermore, for supplying farmers, an interesting business opportunity is created, to cultivate a crop that involves little risk and labour, but generates secure income for up to 25-30 years (once oil palms start to produce after 3-4 years). Over time, the income generated by the company and among supplying farmers further increases job and income opportunities within the region, even more so since important capacity building takes place that prevents young people to migrate into urban areas.
- **Sustainably managed oil palm plantations have better sustainability effects than most alternative production systems** – In Indonesia and Malaysia, primary forest or peat land is often converted into oil palm plantations, with disastrous environmental effects. The assessed contexts in Africa (Ghana, Madagascar, Côte d’Ivoire) and South America (Brazil, Colombia) are different. Direct deforestation to expand palm oil cultivation is only critical in Brazil, even though it is strictly regulated by the national law. In all other contexts—relating to the contexts of the assessed companies at least—oil palms are grown on land that was deforested decades ago. The land was either used for cattle breeding, the production of cash crops such as banana, cocoa, rice or soy, or annual crops grown for self-consumption (e.g. cassava, beans, corn, peanuts, etc.). In some cases, the deforested land turned into a secondary forest because the land was not actively used. Except in the latter case, shifting towards

²⁰ In one ‘BS&RSPO’ certified company, erosion along water streams is a problem, when water levels rise during the rainy season. Here, buffer zones with special vegetation (including shrubs and trees) help to protect the land.

oil palm cultivation involved a net biomass and soil fertility gain²¹. In the assessed contexts, also no indirect deforestation effects were perceived or mentioned. On the social side, when a good outgrower scheme is in place, farmers are definitely better off with oil palms than with labour intensive and rather risky annual crops, which tend to involve low prices, or cash crops that tend to face big price fluctuations and have a negative impact on soil fertility (e.g. cocoa, rubber).

- **Using much less land to produce one ton of oil than alternative oil crops** – From a global perspective, it must be considered that oil palms produce much more oil per unit of land than any other crop (see Figure 14). Although such comparisons depend strictly on yield levels obtained in concrete cases for both oil palms and alternative oil crops, the latter require between 2.5 and 7 times more land than oil palms for the same amount of oil produced (WWF 2016).²²

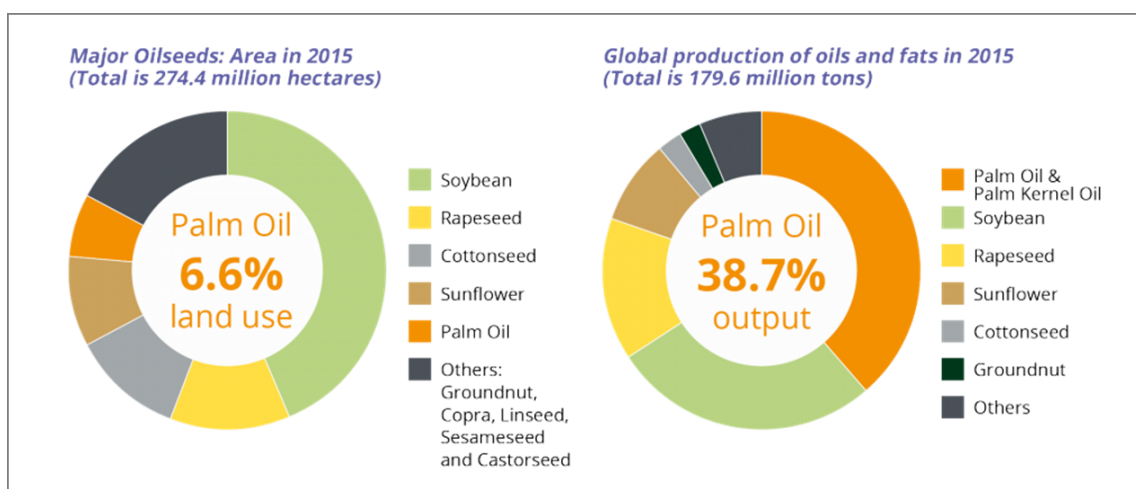

Figure 14 Areas and share of global production of palm oil and other vegetable oils

Source: Oil World 2016.

As a means to promote organic & fair palm oil as a viable option for development, different aspects must be reflected:

- **Support to increase farmers' yields and processors' extraction rates** – To reduce the pressure on deforestation and boost rural development through income generation, it is key to help farmers increase their income. Optimal cover crop management coupled with good fertilization practices are crucial in this respect (see page 26). To increase yields among mills, it is crucial to help especially smaller mills access better extraction technologies, which allow them to boost profits while reducing, at the same time, the negative effects on the environment (i.e. water pollution, GHG emissions) thanks to POME reductions.
- **R&D support to advance technical solutions to abolish 3-MCPD compounds** – These chloride compounds are formed when FFAs are eliminated as part of CPO bleaching. Scientists suspect that they are carcinogenic to humans. Therefore, their reduction or rather their elimination is of great importance when using palm oil in food manufacturing. Guidelines exist to reduce the 'chloride contamination' at the level of oil palm production and oil processing (BLL 2016), but a sound technology to eliminate these compounds at the level of the refinery is not

²¹ Oil palm plantations store more carbon in plants and soil than alternative production systems.

²² For the Swiss context, Batlogg & Bernet (2018) calculated an area coefficient of 2.48 for conventional rape and 4.34 for organic rape in comparison to palm oil.

yet established. One 'BS&RSPO' certified company plans to develop and use special biochar for this purpose. To help upgrading the intrinsic quality of organic palm oil, it would be important to support such endeavours.

- **Tariff preference for organic & fair palm oil** – Palm oil is the vegetable oil with the lowest production costs. As a means to protect their own oil and fat industry, and the farmers growing rapeseed, sunflower seed, or soy, especially Western countries tend to apply high tariffs on palm oil. These tariffs vary between countries. Switzerland applies very high import duties on palm oil for most countries, but with zero tariff for LDCs (e.g. Madagascar, Côte d'Ivoire) (see Annex A). While these preferences are important to promote sourcing from low-income countries, it would be essential to differentiate import duties and apply reduced tariffs for e.g. organic & fair palm oil. Currently, the same import duties apply for certified and conventional palm oil. Hence, certified organic palm oil is more expensive for Swiss manufacturers than conventional rapeseed oil (see **Fehler! Verweisquelle konnte nicht gefunden werden.**)— which is a disincentive for making palm oil production more sustainable, which is a desired goal from a development perspective.
- **Consumer awareness and promotion for organic & fair palm oil** – In recent years, different campaigns have sensitized consumers in the Western world to the environmental and social costs of palm oil production. Research evidence supports this perception, particularly for the Asian context (i.e. Indonesia and Malaysia), criticizing also RSPO for not leading to a more beneficial situation (Barthel et al. 2018; Carlson et al. 2018; Alexandre et al. 2014)— apart from increased net income gains on the side of farmers (Morgans et al. 2018). While being aware that also in the South American and African contexts important deforestation occurs driven by palm oil expansions from both agro-industrial and small-scale mills—as documented by Bennett et al (2018) for Peru and Ordway et al (2019) for Cameroon²³—our findings still show for the assessed contexts that 'Organic&RSPO' certified palm oil companies have a positive sustainability performance. Thus, special communication efforts will be critical to make consumers understand that *“'Organic&RSPO' and 'Organic&Fair' certified palm oil involve a good sustainability performance”*.
- **Active lobbying for best practices** – Assessment results show that there are still different critical 'hotspots' that should be addressed to further enhance the 'sustainability performance' of 'BS&RSPO' certified palm oil companies (see Figure 13). Such 'lobbying for best practices' would further increase the 'showcase character' of these companies and create a highly relevant leverage for policy dialogue activities at the national and global levels to increase the overall impact of palm oil production. Ideally, these communication efforts should be based on further research that strengthens the argument how certain measures—especially (a) technologies for POME management to reduce GHG emissions, (b) effective production of compost and organic fertilizers using POME, (c) optimal Pueraria cover crop management, (d) buffer zone strategies to boost biodiversity and control diseases, (e) cost-effective and beneficial outgrower schemes²⁴.— contribute to improved sustainability outcomes. A practical way would be to develop a technical guide based on the best practices already implemented by the visited well-performing companies and complemented by other companies implementing

²³ Also, Vijaiy et al. 2016 argue that the largest areas of vulnerable forest linked to a potential expansion of palm oil production are in Africa and South America.

²⁴ The existing experiences of using digitalized internal control systems (ICS) is highly interesting in this respect, as they have interesting potential to improve traceability aspects and improve service delivery to outgrowers (e.g. provision of technical advice, access to organic fertilizers).

'best practices'. All these companies could then ideally be part of an international stakeholder platform committed to boost sustainability outcomes through palm oil production.

5. References

- Alexandre N., Kelly K, Tecot St. 2014.** How "Sustainable" is the RSPO? [Online Version](#) [March 3 2014].
- Batlogg V, Bernet T. 2018.** Flächenerträge von Schweizer Rapsöl und Palmöl im Vergleich. Kurzbericht für die Schweizer Palmöl Koalition. [Online Version](#). FiBL Switzerland [August 2018].
- Barthel M., Jennings St., Schreiber W., Sheane R., Royston S., Fry J., Leng Khor Y., McGill J. 2018.** Study on the environmental impact of palm oil consumption and on existing sustainability standards. Report elaborated for the European Commission, DG Environment. [Online Version](#). 3Keel LLP and LMC International Ltd. [February 2018]
- Bennett A., Ravikumar A, Paltán H. 2018.** The Political Ecology of Oil Palm Company-Community partnerships in the Peruvian Amazon: Deforestation consequences of the privatization of rural development. *World Development* 109 (p. 29-41).
- BLL 2016.** Toolbox for the Mitigation of 3-MCPD Esters and Glycidyl Esters in Food. Bund für Lebensmittelrecht und Lebensmittelkunde (BLL). [Online Version](#). Germany.
- Carlson K., Heilmayra R., Gibbs H., Noojipadyg P., Burns D., Morton D., Walker N., Paolij G., Kremenk C. 2017.** Effect of oil palm sustainability certification on deforestation and fire in Indonesia. [Online Version](#). Proceedings of the National Academy of Sciences (PNAS): 115-1 (p. 121-126).
- Chase L, Henson I. 2010.** A detailed greenhouse gas budget for palm oil production. *International Journal of Agricultural Sustainability* 8 (3) (p. 199-214).
- Daoui A. 2019.** How to import Palm Oil? Text available [online](#) under <https://www.waysto-cap.com/blog/how-to-import-palm-oil/>
- Gatto M., Wollni M., Asnawi R., Qaim M. 2017.** Oil palm boom, contract farming, and rural economic development: Village-level evidence from Indonesia. *World Development* 95 (p. 127-140).
- Kaye L. 2017.** RSPO touts progress on sustainable palm oil, but critics aren't buying it. Leadership & Transparency. [Online Version](#) [Feb 03 2017].
- Morgans C, Meijaard E, Santika T, Law E, Budiharta S, Ancrenaz M, Wilson K. 2018.** Evaluating the effectiveness of palm oil certification in delivering multiple sustainability objectives. *Environmental Research Letters* 13 (6).
- Ordway EM, Naylor RL, Nkongho RN, Lambin EF. 2019.** Oil palm expansion and deforestation in Southwest Cameroon associated with proliferation of informal mills. *Nature communications* 10 (1), (p. 114).
- Pye O. 2013.** An analysis of transnational environmental campaigning around palm oil. The palm oil controversy in Southeast Asia: *A transnational perspective* (p. 179-199).

- Rhebergen T., Fairhurst T., Whitbread A., Giller K., Zingore S. 2018.** Yield gap analysis and entry points for improving productivity on large oil palm plantations and smallholder farms in Ghana. *Agricultural Systems* 165 (p. 14-25).
- RSPO. 2018.** Principles & Criteria for the Production of Sustainable Palm Oil. <https://rspo.org/key-documents/certification/rspo-principles-and-criteria>
- Schilling R. 2018.** Coop's palm oil vision. Presentation at the Advisory Group meeting August 28 2018.
- Schilling R. 2019.** Coop's palm oil vision. Presentation at Biofach 2019 at Nuremberg Germany as part of the session 'Towards improved sustainability of palm oil, how can organic certification help enhance environmental and social impact?' on February 14 2019.
- Schuchardt F., Stichnothe H., Vorlop K.-D. 2011.** Abwasser- und Abfallverwertung in Palmölmühlen als Beitrag zum Klimaschutz. *Landbauforschung - vTI Agriculture and Forestry Research* 2 2011 (61) (p. 93-100).
- Vijay V, Pimm St, Jenkins C, Smith S. 2016.** The Impacts of Oil Palm on Recent Deforestation and Biodiversity Loss. *PloS one* 11 (7), (p. 1-19).
- WWF. 2016.** Auf der Ölspur– Berechnungen zu einer palmölfreieren Welt. [Online Version](#). WWF Deutschland, Juli 2016.

6. Links to relevant standards

- Bio Suisse Standards for the Production, Processing and Trade of 'Bud' Products 2019 <https://www.bio-suisse.ch/en/home.php>
- Fair for Life Programme, Certification Standard for Fair Trade and responsible supply-chains. 2019. <http://www.fairforlife.org>
- Fair Trade USA Agricultural Production Standard. www.fairtradecertified.org
- Roundtable for Sustainable Palm Oil (RSPO):
 - RSPO 2013 und RPSO 2018 [[link](#)]
 - 2nd Draft RSPO P&C 2018 [[link](#)]
- Palm Oil Innovation Group (POIG) [[link](#)]
- EU Organic Regulations
 - 834/2007 [[link](#)]
 - 889/2008 [[link](#)]
 - ICS Guideline [[link](#)]
 - 848/2018 [[link](#)]
 - Traces [[link](#)]

7. Annexes

Annex A *Duty rates for crude palm oil in Switzerland*

Tariff Code	1511.1090
Item	Crude palm oil
Use	Food industry use
	[except applications for spreads, where duty is CHF 6.-/100kg gross]

Duty rates:

Normal	116.05 CHF	100 kg gross
LDC*	0.00 CHF	100 kg gross

*** LDC countries:**

Afghanistan; Angola; Bangladesh; Benin; Bhutan; Burkina Faso; Burundi; Cambodia; Central African Republic; Chad; Comoros, Union of; Congo, Democratic Republic of the; **Côte d'Ivoire**; Djibouti; Equatorial Guinea; Eritrea; Ethiopia, Fed. Democratic Republic of; Gambia; Guinea; Guinea-Bissau; Haiti; Kiribati, the Republic of; Lao, People's Democratic Republic; Liberia; **Madagascar**, Republic of; Malawi; Mali; Mauritania; Mozambique; Myanmar, Union of; Nepal, Federal Democratic Rep.; Niger; Rwanda; Samoa; Sao Tomé and Príncipe; Senegal; Sierra Leone; Solomon Islands; Somalia, Federal Republic of; Sudan; Tanzania, United Republic of; Timor-Leste; Togo; Tuvalu; Uganda; Vanuatu; Yemen; Zambia

Source: <https://xtares.admin.ch>

Annex B Fractions and derivatives of crude palm oil

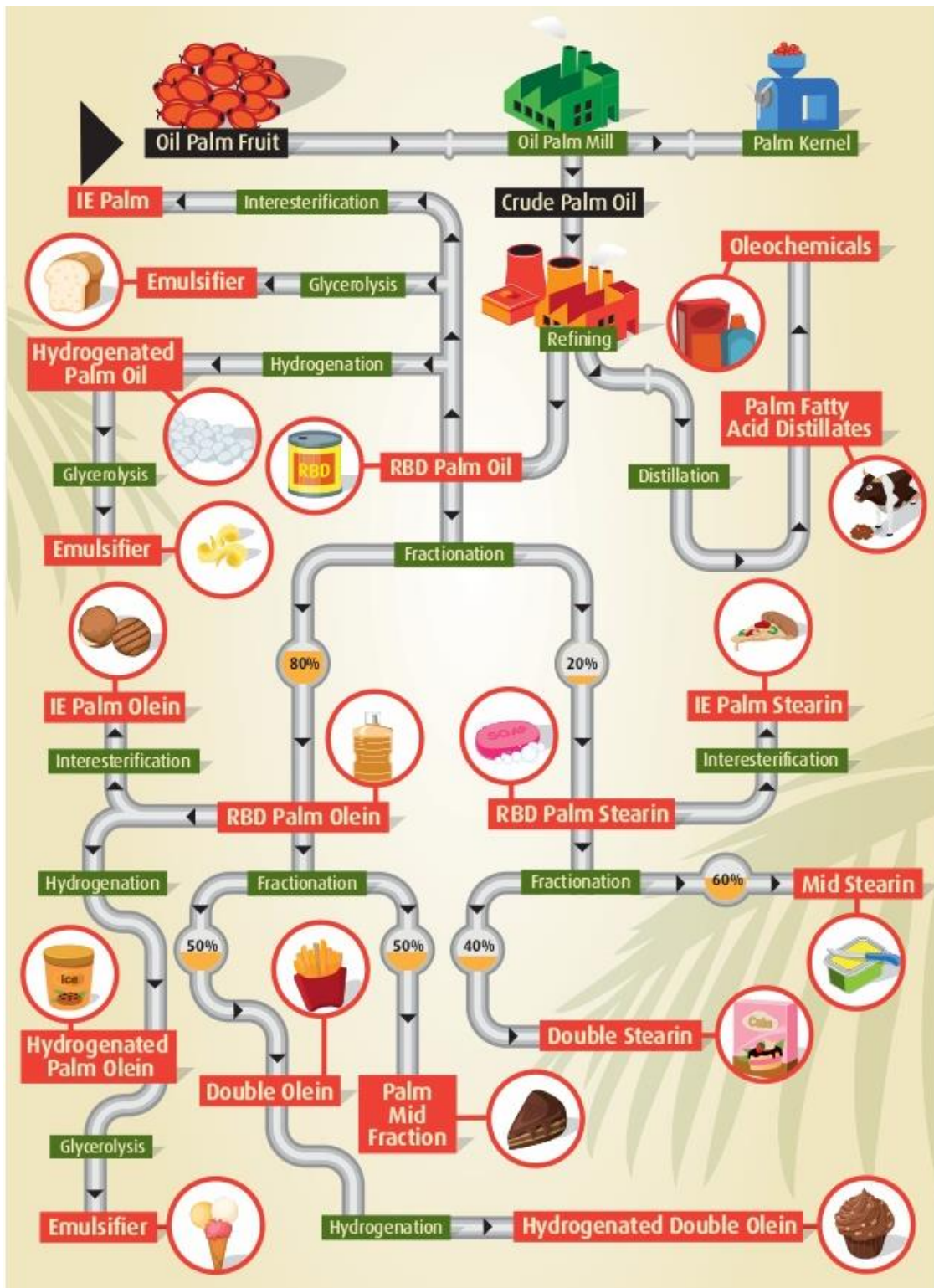

Note: Palm kernel fractions and derivatives are similar.

Source: www.greenpalm.org

Annex C Certification schemes applied by RSPO

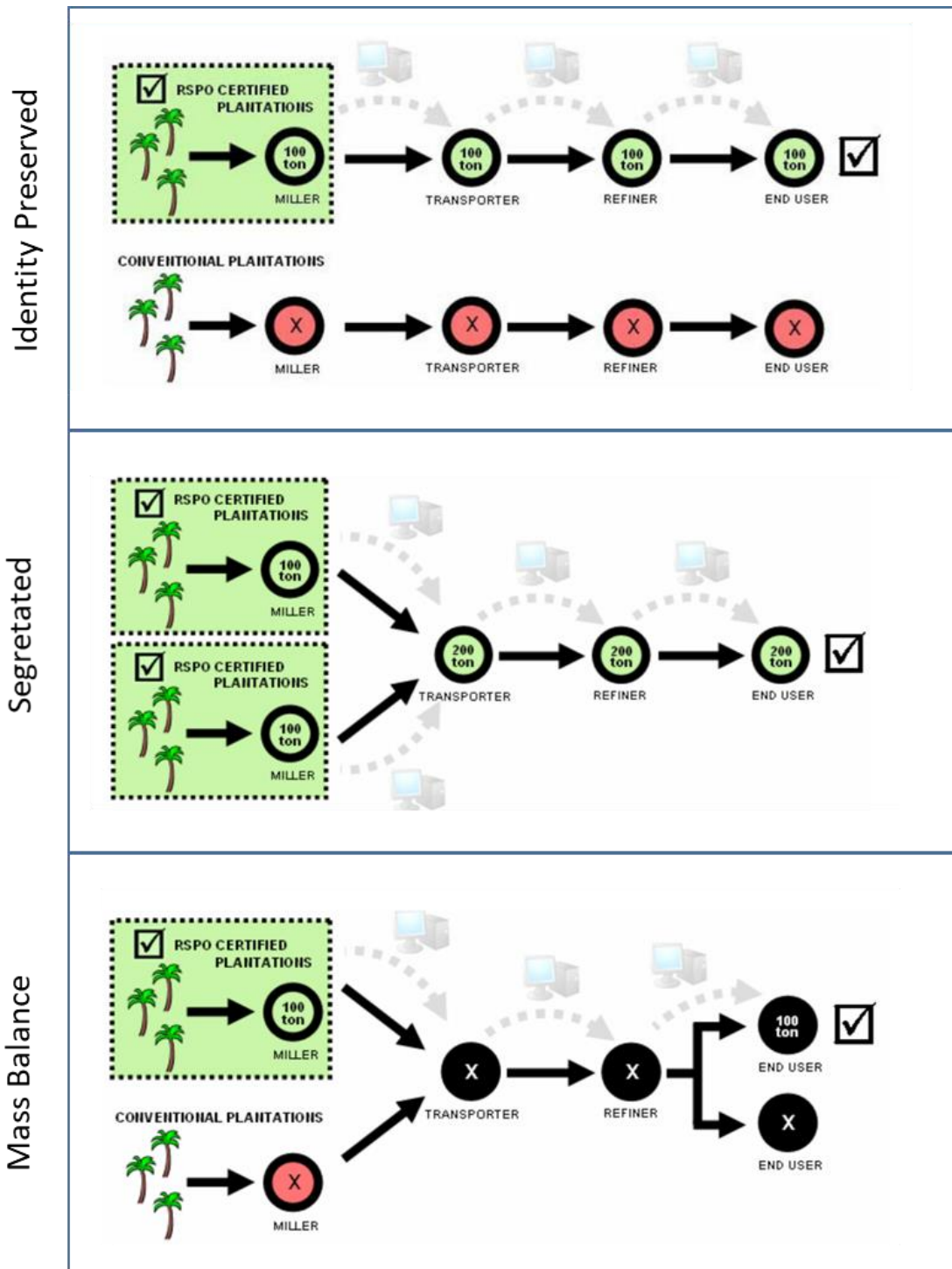

Source: www.rspo.org

Annex D General palm oil development curve

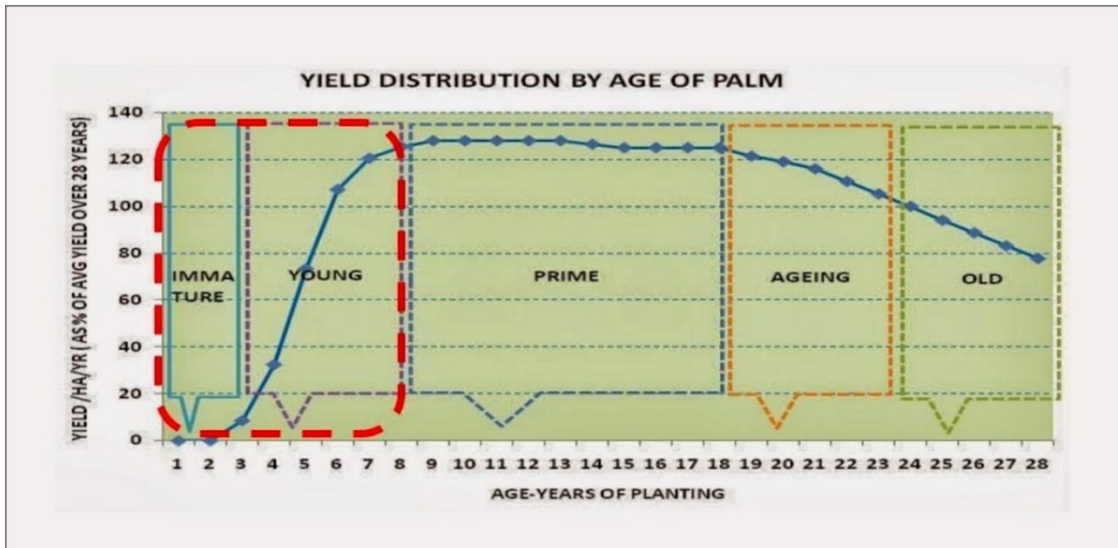

Source: <https://klseimoney.blogspot.com/search?q=palm>

Annex E Process flowchart relating to CPO and PKO production

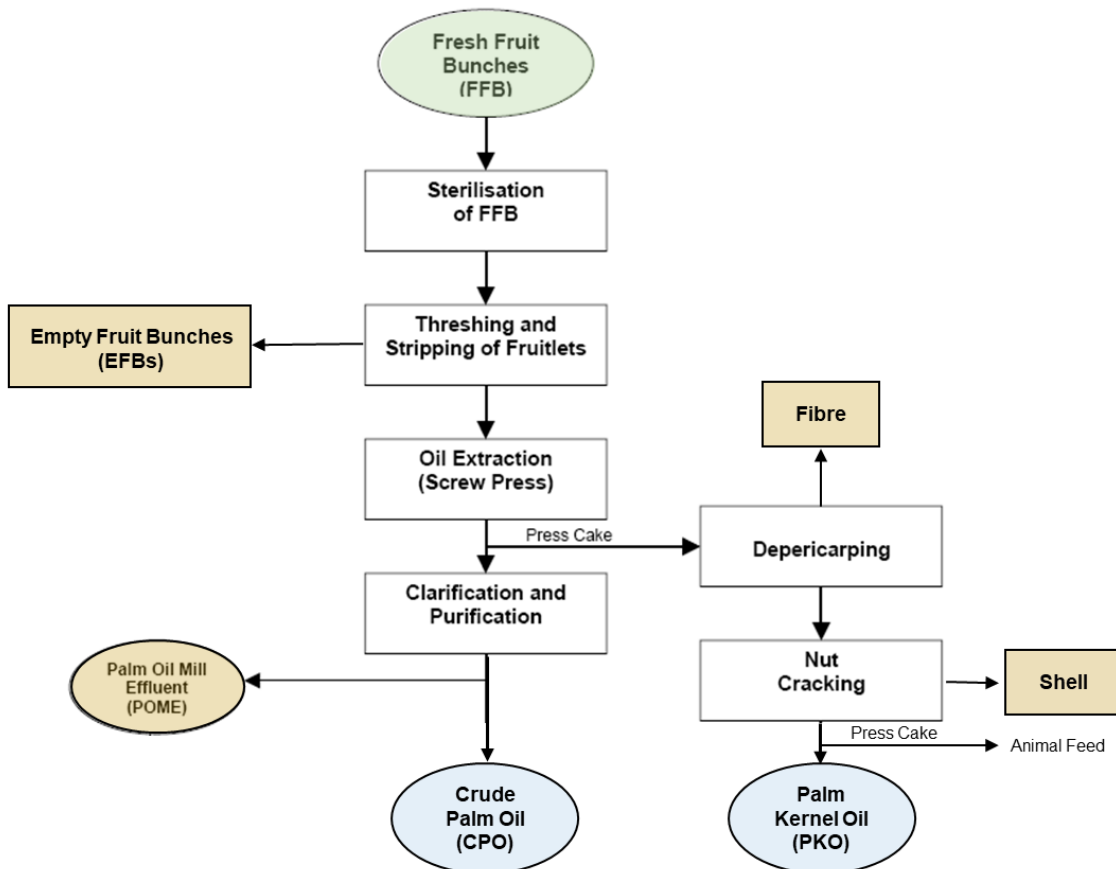

Annex F Brief description of companies involved in the assessment

Company	Category
<p>Serendipalm was initiated by the natural cosmetic company Dr. Bronner's. It is a rather small palm oil producer in Ghana fulfilling the organic (EU organic) and fair trade standards (Fair for Life). The company sources from over 700 local small-scale farmers, who receive fair prices and trainings in the context of organic farming. The company owned processing infrastructure involves around 250 persons, mainly women, also receiving fair wages and good working conditions. Moreover, the fair trade premium enables the local implementation of social projects. Altogether, around 3'000 persons benefit directly or indirectly from Serendipalm's activities. The company provides organic and fair trade certified palm oil to GEPA and Rapunzel, for instance.</p>	<p>"Fair&Organic"</p>
<p>Norpalm Ghana Ltd. (NGL) is among the four leading industrial palm oil milling companies in the country, processing more than 80'000 tons of fresh fruit bunch per year. NGL's nucleus estates comprise an acreage of 4'300 ha planted with high-yielding planting materials. NGL's workforce totals 284. In addition, approximately 1'250 contract workers are engaged when needed, predominantly during harvesting, pruning and weeding. The company was established 1998 as a vehicle to acquire the assets of the former state owned enterprise National Oil Palms Ltd.</p>	<p>"RSPO only"</p>
<p>B-BOVID Ltd. is an agro-business located in the Western Region of Ghana. It is a relatively new transformational agro-industrial company promoting, thanks to a recent joint venture with an investor, a new business model of social inclusive commercial farming, which combines innovative agricultural practices, ecological farming, Climate Smart Agriculture, agroforestry and social entrepreneurship. With focusing on ecological production, it will be aiming at conserving the environment and creating jobs to help reduce poverty in rural communities.</p>	<p>"Conventional"</p>
<p>Central Oil Mills Ltd. is a small company with an own mill processing CPO oil from its own plantation (50ha) and contracted local farmers (125 ha, 10 farmers). The company processes around 200 t FFB per month, which results in a yearly production of around 400 t of CPO, yet having a capacity that is three times higher. The CPO is sold to customers within Ghana (for soap), who partly also export the oil to Kenya, Togo, and Burkina Faso. The company was supported by SWAPP to introduce best on-farm practices (use of fertilizers) and improve its processing infrastructure (improved sterilizer and cooker). The company supports with loans the rehabilitation and installation of new plantations among local farmers.</p>	<p>"Conventional"</p>
<p>Juaben Oil Mills Ltd., involves both a CPO and PKO mill and a refinery, and is therefore involved in the primary and secondary industrial processing of red crude palm oil and refining of cooking oil. Center. The Company is a privately owned Ghanaian company established in 1981. It has an own plantation (425 ha) but sources most FFB from outgrowers (1100 ha) and independent smallholders that sell through intermediaries. 50 locally present minimills are important competitors, especially in the lean season (Nov-Feb). The CPO's mill capacity is 15 t FFB per hour. The oil is sold to national clients, who are partly involved in export ventures. In the high season, the company involves directly more than 150 full time employees.</p>	<p>"Conventional"</p>

<p>DAABON is a family owned and managed company with its headquarters and farms located in Santa Marta, Colombia. Established in 1914, the company has grown into one of the world's leading suppliers of organic tropical crops, including banana, coffee, palm oil and cocoa. In regard to palm oil, the company manages own plantations (> 9'000 ha), two CPO mills and a refinery. It also buys FFB from local contracted farmers (almost 30'000 t per year). Most production is organic & RSPO certified. The mill's capacity is of 600 t/day, with an average use of 380 t/day. The oil is sold within Colombia or exported.</p>	<p>"BS&RSPO"</p>
<p>Agropalma goes back to a first company that started palm oil activities in 1982 in Brazil. With acquisitions, the company has grown over time and currently involves 39,000 ha of planted area, out of which 4'107 ha relate to organic. Organic FFB are processed in one of the 6 CPO mills the company owns. Agropalma also operates 2 refineries and fractionation plants, plus 2 fats and shortenings production units. Located in the Amazon basin, the company owns and protects also 64,000 hectares of natural forests reserves. All oil is certified RSPO. Organic oil goes all into export. Agropalma also sources from local family farms and independent companies, all of which are currently not organically certified.</p>	<p>"BS&RSPO"</p>
<p>Savonnerie Tropicale / Huilerie Melville (STHM) is a previously state owned, presently privately managed plantation and oil mill in south-eastern Madagascar. The total area of the farm is 2'804 ha with 1'226 ha of palm plantations. Total production is 4'500 t FFB and 880 t CPO. The company is Bio Suisse (since 2009) and RSPO IP (since 2015) certified. Sourcing FFB from smallholders is planned in the frame of a PPP project with the German development agency GTZ and the Swiss importer Nutriswiss as partners. The planned outgrower scheme will involve 2 cooperatives, approx. 200 farmers each with a production area of around 500 ha. Oil palms will be cultivated in a diverse cropping system and provide STHM with FFB. The smallholders will be Bio Suisse, RSPO, and fair trade certified.</p>	<p>"BS&RSPO"</p>